KODAK EASYSHARE D825 / D1025 Digital Frame / Decor Series



Extended user guide

www.kodak.com

For help with your digital frame, www.kodak.com/go/digitalframesupport

Kodak

Eastman Kodak Company

Rochester, New York 14650

© Eastman Kodak Company, 2009

All screen images are simulated.

Kodak and EasyShare are trademarks of Eastman Kodak Company.

4H6823_en

Top—buttons and controls

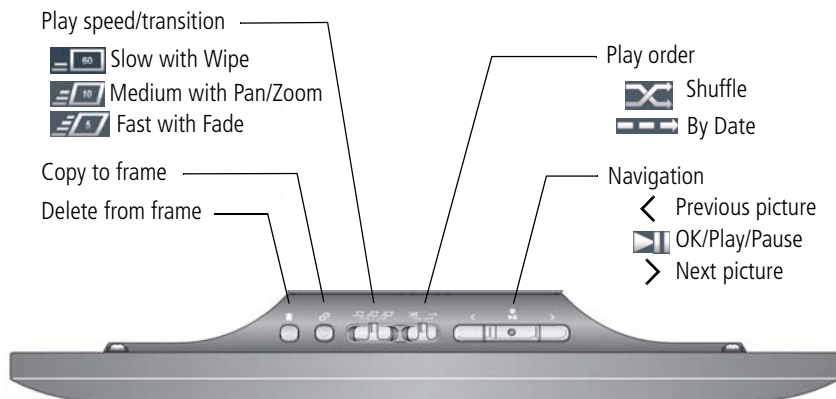

Side—power and connectors

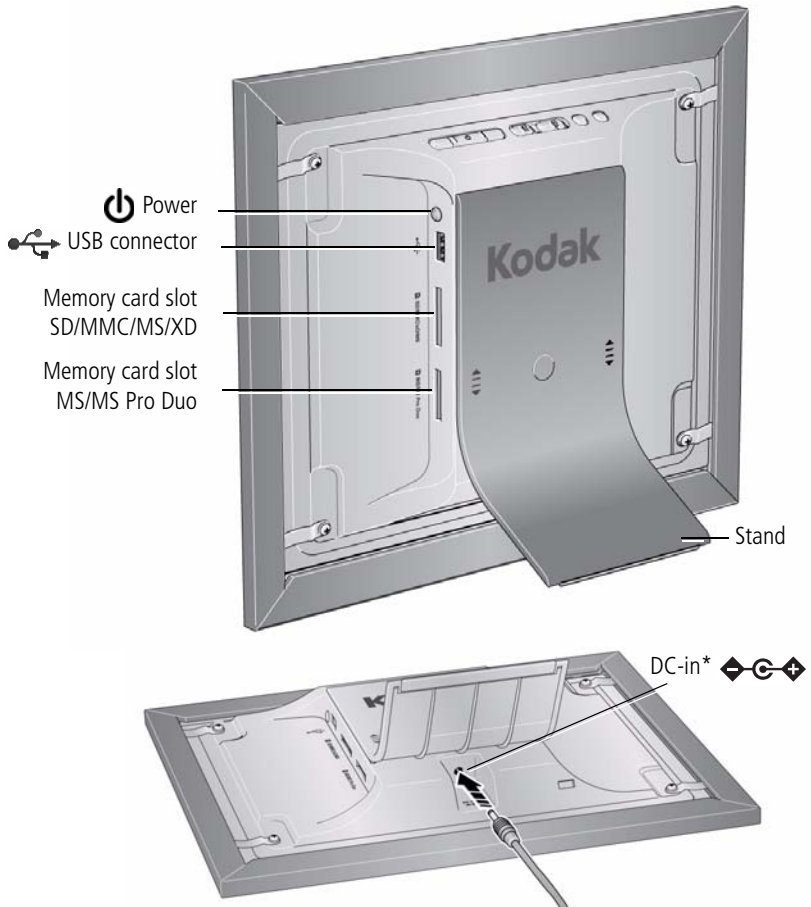

* See [Attaching the power cable, page 3](#), [Attaching the D825 stand and faceplate, page 1](#), and [Attaching the D1025 stand and faceplate, page 2](#).

Table of contents

1 Getting started	1
Attaching the D825 stand and faceplate.....	1
Attaching the D1025 stand and faceplate.....	2
Attaching the power cable	3
Turning your frame on and off	4
Inserting a memory card.....	5
Connecting a USB device.....	5
Adding a new standard picture frame	6
2 Viewing and copying pictures	11
Viewing pictures from internal memory.....	11
Viewing pictures from a memory card.....	11
Navigating through your pictures.....	12
Changing play speed, transitions, and order	13
Copying pictures to internal memory.....	14
Deleting pictures from the frame	16
3 Troubleshooting and support	17
Learning more about your frame.....	17
Maintaining your frame	17
Picture frame problems	18
Identifying graphic messages.....	19
Identifying error messages.....	20
Upgrading your firmware.....	21
Setting automatic shut-off time	22
4 Appendix	23
Digital frame specifications.....	23
Important safety instructions	24
Limited warranty.....	25

1

Getting started

Welcome to your KODAK EASYSHARE Digital Frame. Viewing your pictures couldn't be simpler!

Attaching the D825 stand and faceplate

- Fit the stand into the slot and slide to lock.
- To adjust the display angle, move the stand to a different slot.

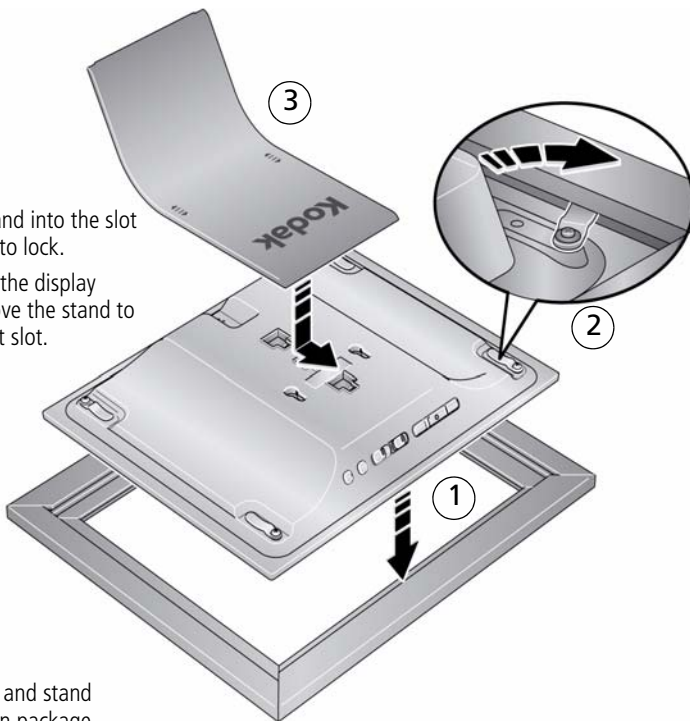

Faceplate and stand included in package.

Attaching the D1025 stand and faceplate

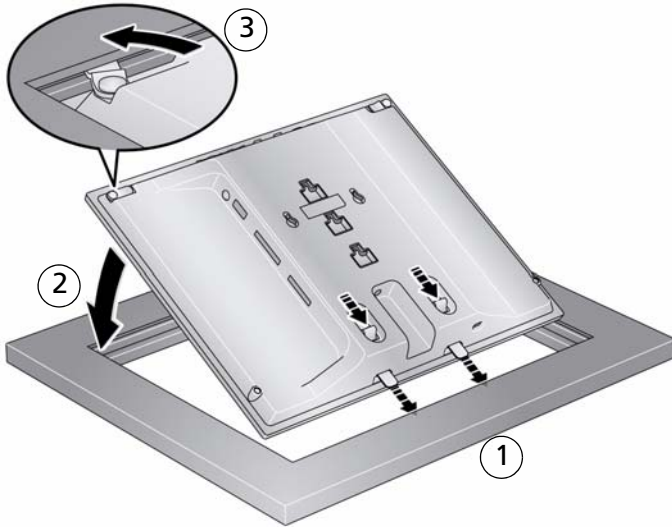

- Fit the stand into the slot and slide to lock.
- To adjust the display angle, move the stand to a different slot.



Faceplate and stand included in package.

Attaching the power cable



CAUTION:

Do not use this power cable with other devices, including digital cameras.

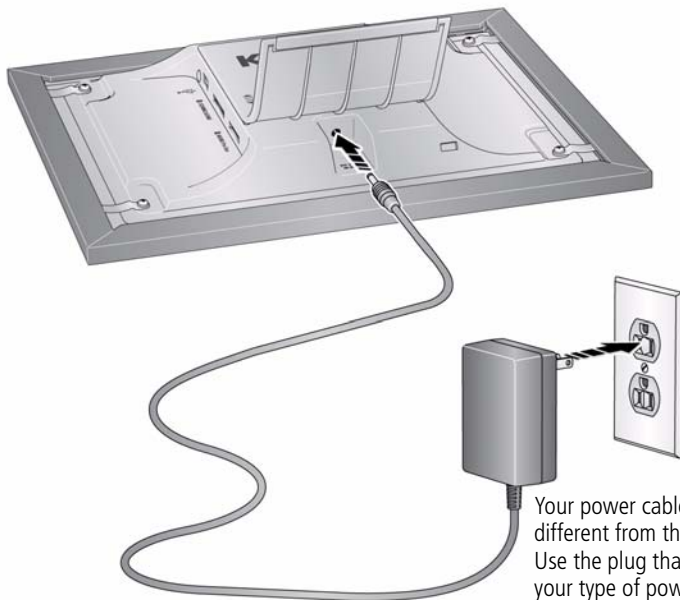

Your power cable may look different from the one pictured. Use the plug that accommodates your type of power outlet.

Turning your frame on and off

 Press the power button

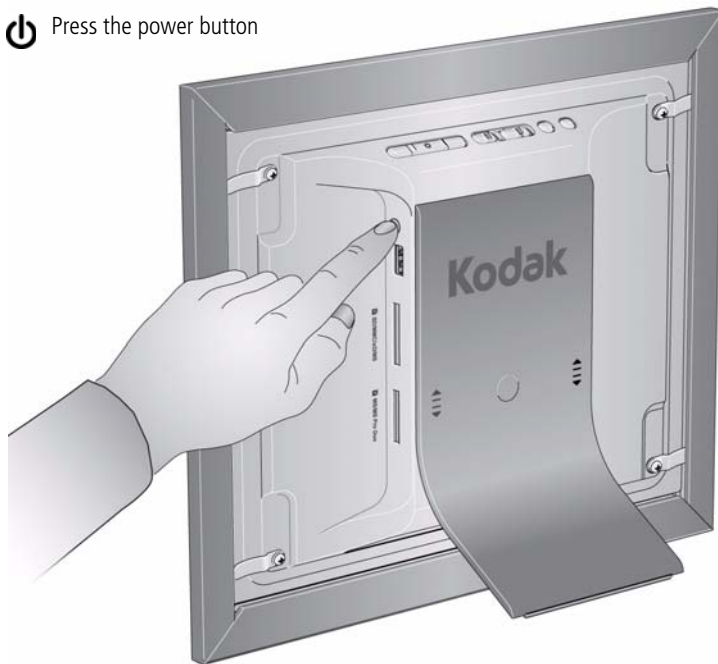

NOTES

- The frame automatically turns on when you plug it in for the first time.
- Your frame may contain pre-loaded sample pictures, which only play until you copy pictures to your frame or insert a memory card or USB device.
- The frame automatically shuts off after 16 hours. To change the automatic shut off time, [see page 22](#).

Inserting a memory card

- To insert a card, push it firmly into the slot.
- To remove a card, pull it out of the slot.

Top slot*:

SECURE DIGITAL/SECURE DIGITAL High Capacity (SD/SDHC)

MMC (MULTIMEDIA Card)

XD

MS (MEMORY STICK)

Bottom slot:

MS/MS Pro Duo (MEMORY STICK)

***IMPORTANT:** Do not insert an MS Pro or MS Pro Duo card in the top slot. It may be difficult to remove.



Connecting a USB device

Supported USB devices include a flash drive, card reader, hard drive*, etc.

USB devices and cables are sold separately.

* External hard drives must be self-powered and formatted as FAT32.

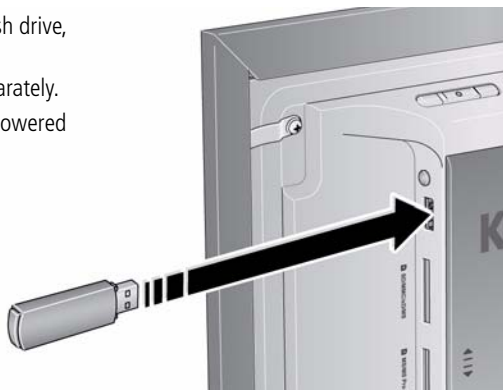

Adding a new standard picture frame

You can personalize your KODAK EASYSHARE Digital Frame by putting a standard picture frame over the digital frame's panel. Match your home décor and style by choosing from the hundreds of standard picture frames on the market, even a favorite you might already have.

Choosing a standard picture frame size

KODAK EASYSHARE Digital Frame model	Use a standard picture frame that accommodates this photo size (without a matte)
D825	8 x 10 in. (20.3 x 25.4 cm)
D1025	8 x 10 in. (20.3 x 25.4 cm)

Standard picture frames have different attachment styles. Your digital frame fits these most commonly available styles of standard frames:

- Slot—frames with a slot around the inside perimeter ([see page 8](#))
- Clip—frames with a rotating clip around the perimeter of the frame ([see page 9](#))
- Tab—frames with bendable metal tabs ([see page 10](#))

Picture frame styles that don't fit

Several standard picture frame styles are not compatible with your KODAK EASYSHARE Digital Frame. A compatible standard picture frame must accept the dimensions of the digital frame's attachment area. The dimensions of the attachment areas are:

KODAK EASYSHARE Digital Frame model	Digital frame's attachment area dimensions
D825	8 x 10 x 0.165 in. deep (20.3 x 25.4 x 0.4 cm)
D1025	8 x 10 x 0.165 in. deep (20.3 x 25.4 x 0.4 cm)

The following types of standard picture frames will not fit on your EASYSHARE Digital Frame.

- Frames that secure a photo by pressing it between two pieces of glass.
- A deep frame that's designed to hold 3-dimensional objects instead of photos.
- Frames with inserts in which the insert holds the standard picture size.
- Frames with a hinged or otherwise non-removable back.
- Frames with a curved or uneven mounting surface.
- Frames with a round, oval, or other non-rectangular mounting area.
- Frames in which you slide the picture into one end.*
- Handcrafted frames.*

* You may be able to use these frame types. Check for individual frame compatibility.

General attachment details

- 1 If the faceplate that was packaged with your frame is attached, remove it ([see page 1](#)).
- 2 Remove the back, backing material, and the glass from the standard picture frame. Use CAUTION when handling the glass, the edges are sharp.

NOTE: **You must remove the glass.**

Store the original faceplate and contents of the standard picture frame in the box that came with your digital frame. Keep for later use.

- 3 Place the standard picture frame face down on a protected flat surface, and place the digital frame into the picture frame.
- 4 Attach the frames together according to the following directions. Keep any leftover foam spacers for later use.
- 5 When attached, make sure the digital frame is secure within the picture frame and can't shift or move around.

Attach a slot-style standard picture frame

SLOT-style

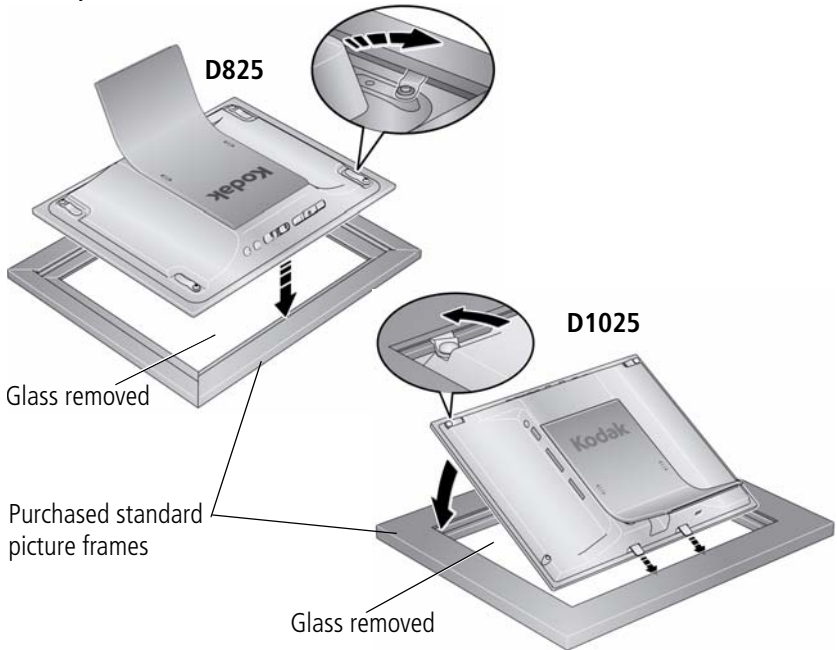

- Use the clips that are attached to the digital frame's back panel.
- Rotate and depress the clips as needed to engage the slot in the standard frame.

If necessary:

- If a deep picture frame places the slot above the clips, carefully bend the clips up—slightly above the slot. Then, rotate and depress the clips to slide them into the slot.
- Tighten the screws to secure the clips. Be careful not to over-tighten.

Attach a clip-style standard picture frame

CLIP-style

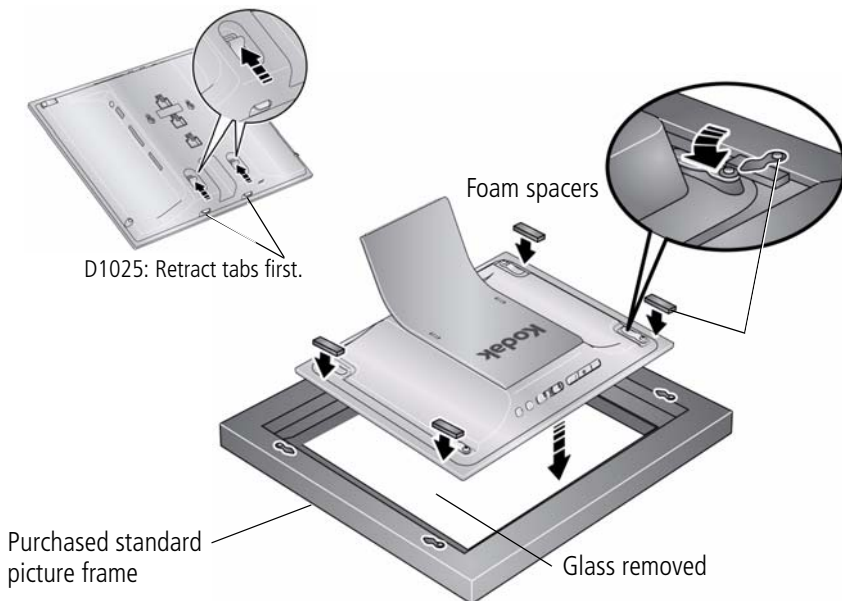

- Use the clips that are attached to the standard picture frame.
- Use the included self-stick foam spacers to fill any gap between the digital frame's back panel and the clips on the standard frame. Stack the spacers if necessary. Avoid adding more spacers than necessary to prevent excessive force against the clips.

If necessary:

- Tighten the screws to secure the clips. Be careful not to over-tighten.

Attach a bendable metal tab-style standard picture frame

TAB-style

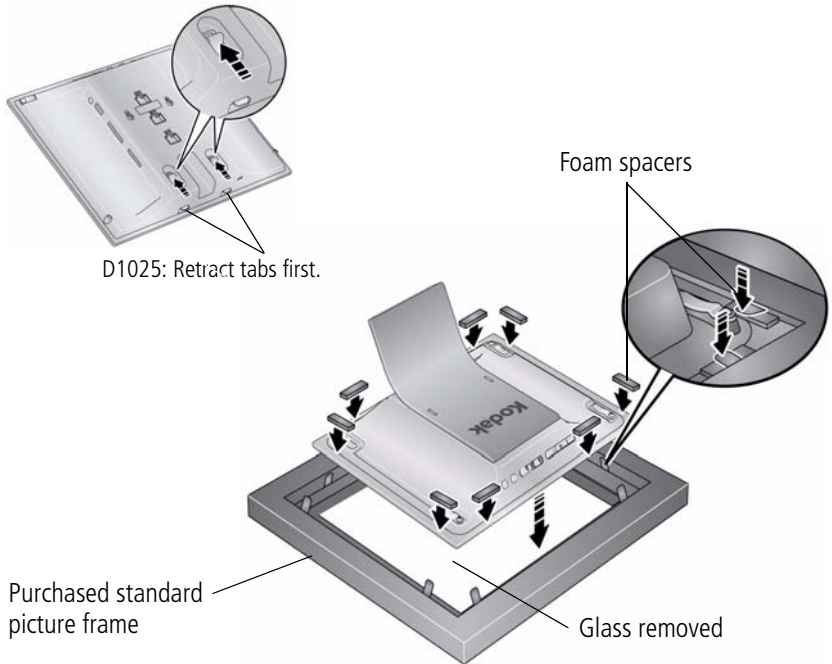

- Bend the metal tabs down to secure the digital frame to the standard frame.
- If necessary, use the included self-stick foam spacers to fill any gap between the digital frame's back panel and the metal tabs.

2

Viewing and copying pictures

Pictures play from the frame's internal memory when no card or USB device is inserted.

Pictures play from a memory card or USB device when one is inserted in the frame.

NOTE: Your frame may contain pre-loaded sample pictures, which play only when there are no other pictures loaded (from a memory card, USB device, or internal memory). Sample pictures may not be deleted.

Viewing pictures from internal memory

- Turn on the frame.

The pictures in your frame's internal memory play automatically.

NOTE: Make sure no memory card or USB device is inserted in the frame.

To copy pictures into the frame's internal memory, see [page 14](#).

Viewing pictures from a memory card

- Turn on the frame. Insert a memory card, USB flash drive, or other USB device (see [page 5](#)).

Your pictures start playing automatically.



Navigating through your pictures

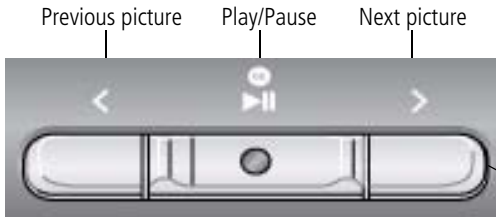



Press the arrow buttons to navigate through your pictures.



Navigation and play buttons

To move more quickly through your pictures, press and hold an arrow button.

-  Previous picture—Go to the previous picture.
-  Play/Pause—Start or pause play.
-  Next picture—Go to the next picture.

Changing play speed, transitions, and order

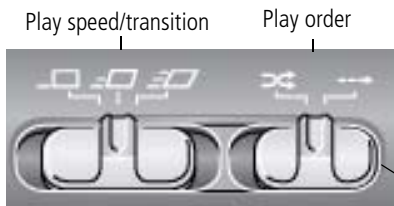

Move the sliders to change the setting.



Play speed and transition

Change how long each picture stays on the screen and the type of transition between pictures.



Slow—pictures change every 60 seconds, with wipe transition.



Medium (default)—pictures change every 10 seconds, with pan and zoom transition.



Fast—pictures change every 5 seconds, with fade transition.

Play order

Change the order in which your pictures play.



Shuffle (default)—pictures play in random order.



By date—pictures play by date, from oldest to newest.

Copying pictures to internal memory

Copy pictures from a memory card or USB device into your frame's internal memory. Copying to a memory card or USB device from internal memory is not supported.



CAUTION:

Removing a card or disconnecting a device while copying may damage your card, pictures, or device.

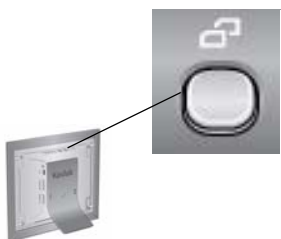

- 1 Insert a memory card or USB device (flash drive, card reader, hard drive). See [page 5](#).

The pictures start playing.

- 2 Press the Previous < or Next > arrow button to display the picture to copy.

- 3 Press the Copy  button.

The copy screen shows where you are copying from. (Example - from SD card to internal memory)



- 4 To copy the currently displayed picture, make sure Copy picture  is highlighted. If not, press the Next > arrow button.

- 5 To copy all of the pictures on the card or USB device, press the Next > arrow button to highlight Copy all .

- 6 Press OK.

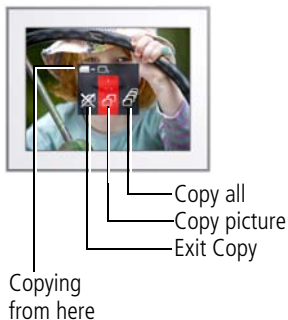

NOTE: Copies are automatically resized to a lower resolution (smaller size). Full resolution is unnecessary for viewing and quickly fills up the frame's memory.

Copying many pictures from your computer

The easiest way to copy a large number of pictures from your computer to your frame's internal memory:

- 1 Insert an empty memory card or USB storage device into your computer.
- 2 Copy all of the pictures from your computer onto the card or USB device.
- 3 Remove the card or USB device from your computer and insert it into the frame.
- 4 Follow the copy directions on [page 14](#).

Copying pictures from your digital camera

The easiest way to copy the pictures from your digital camera to your frame's internal memory:

- 1 Remove the memory card from your camera and insert it into the frame.
- 2 Follow the copy directions on [page 14](#).

Deleting pictures from the frame





You can delete pictures from your frame's internal memory, but not from an inserted memory card or USB device.



- 1 Remove a memory card or USB device from the frame, if inserted.
- 2 While pictures are playing from internal memory, press the Delete  button.



Delete all
Delete picture
Exit delete

- 3 Select the pictures to delete:
 - To delete the currently displayed picture:
Press the Next  arrow button once to highlight Delete picture .
 - To delete all of the pictures from the frame's internal memory:
Press the Next  arrow button twice to highlight Delete all .
- 4 Press OK to confirm the deletion.

3

Troubleshooting and support

For step-by-step product support, visit www.kodak.com/go/digitalframesupport, select your frame model, and select Step-by-Step Solutions & Repair.

Learning more about your frame

- www.kodak.com/go/digitalframes Learn more about your frame
- www.kodak.com/go/digitalframesupport Interactive tutorials
- Frequently asked questions
- Downloads
- Product registration

Maintaining your frame

IMPORTANT: *Always disconnect the power before cleaning. Do not use water, cleaning solutions, or other adhesives on the frame or any of its parts.*









Gently wipe the frame and screen with a clean, dry, lint-free cloth. For fingerprints on the frame, apply light pressure.

Picture frame problems







If...	Try one or more of the following
<p>Frame does not turn on.</p>	<ul style="list-style-type: none"> ■ Make sure the power cable that was included with your frame is connected securely (see page 3). ■ Unplug the power cable for 5 seconds, then reconnect the cable. Press the power button.
<p>Frame freezes up or doesn't work properly.</p>	<ul style="list-style-type: none"> ■ Unplug the power cable for 5 seconds, then reconnect the cable. Press the power button. ■ Reset the frame. Press the Play and Power buttons (see page i) at the same time, and hold for 5 seconds. (Resetting your frame does not erase your saved files.)
<p>Nothing happens when a memory card or USB device is connected.</p>	<ul style="list-style-type: none"> ■ Insert a certified SD/SDHC/MMC/XD Card, with images, into the upper designated card slot, then push to seat it (see page 5). ■ Insert a certified MS/MS Pro Duo Card, with images, into the lower designated card slot only, then push to seat it (see page 5). <p>IMPORTANT: <i>Do not insert an MS Pro or MS Pro Duo card in the top slot. It may be difficult to remove.</i></p> <ul style="list-style-type: none"> ■ Make sure the USB device is connected securely (see page 5). ■ Make sure the file format of your pictures is supported. (See page 23). <p>NOTE: Pictures may take a longer time to display when the files are large or when using a large capacity memory card or other connected device.</p>

Identifying graphic messages

Graphics appear on the screen to let you know what's happening with your pictures and your frame.

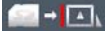
Graphic	Description
	Internal memory—the current picture source is the frame's internal memory.
	Memory card—the current picture source is an inserted memory card.
	USB device—the current picture source is a USB flash drive or other USB device.
	Pause—picture play is paused.
	Copy—appears when you press the Copy button (see page 14). Default selection is Copy picture (copy one at a time).
	Delete—appears when you press the Delete button (see page 16). Default selection is Exit (clear the delete screen).
	Copy complete
	Delete complete
	Deleting from a card or USB device is prohibited. You may only delete pictures from the frame's internal memory.

Identifying error messages



Error icon and meaning	Try one or more of the following
 <p>The card/device is empty.</p>	<ul style="list-style-type: none"> ■ Insert a different card or device with pictures (see page 5).
 <p>The card/device is unreadable or corrupt.</p>	<ul style="list-style-type: none"> ■ See page 23 for supported file formats.
 <p>Internal memory is full, unable to copy.</p>	<ul style="list-style-type: none"> ■ Delete pictures from internal memory (see page 16).
 <p>Copy error—no memory card or USB device is inserted.</p>	<ul style="list-style-type: none"> ■ Insert a memory card or USB device and press the Copy button again.
 <p>Copy error.</p>	<ul style="list-style-type: none"> ■ Recopy the picture to a different memory card or USB device. ■ Turn off the frame, then turn it back on. Insert the card or device in the frame. ■ Try the copy again. If the problem persists, contact customer support help, at www.kodak.com/go/digitalframesupport.
 <p>Delete error.</p>	<ul style="list-style-type: none"> ■ Turn off the frame, then turn it back on. ■ Try the delete again. If the problem persists, contact customer support help, at www.kodak.com/go/digitalframesupport.
 <p>Unknown error.</p>	<ul style="list-style-type: none"> ■ Turn off the frame, then turn it back on. If the problem persists, contact customer support help, at www.kodak.com/go/digitalframesupport.

Upgrading your firmware

Firmware is the software that runs on your frame. Download and install the latest version from the Web to keep your frame up to date.

Check your frame's current firmware version



- 1 Turn your frame on.
- 2 Press the Power  and Next  buttons at the same time and hold for 5 seconds.
- 3 Note the firmware version on the About screen.

Download the latest firmware

- 1 On your computer, go to www.kodak.com/go/digitalframedownloads.
- 2 Enter your frame model and note the firmware version that's available for download. If it's newer than the version on your frame, continue with these download and upgrade directions.
- 3 Follow the screen directions to download the frame firmware to your computer.
- 4 When the firmware is downloaded, copy the IMG file to the root directory (top level, not in a folder or subfolder) of a memory card or USB flash drive.

Upgrade your frame

- 1 Remove the memory card or USB flash drive from your computer, then insert it into the frame.

The Install Firmware screen appears on your frame. This screen only appears when the firmware upgrade file (IMG) is present on the card or device.

- 2 Highlight the newer firmware version, then press OK  to begin the upgrade.

IMPORTANT: *Do not turn off the frame or remove the memory card or USB flash drive during the upgrade! When the upgrade is complete, your frame automatically restarts. If it doesn't, turn the frame off, then back on.*

Setting automatic shut-off time

The energy saver feature automatically turns the frame off after 16 hours. The screen dims 5 minutes before it turns off. Press a button to reset the shutdown for 10 minutes later.

To change the shut-off time or turn the feature off:

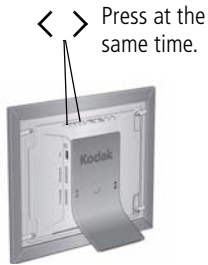

- 1 Press and hold both the Previous < and Next > buttons for 5 seconds.
- 2 Press < or > to highlight a shut-off time, then press OK.
 - 8—Frame automatically turns off after 8 hours.
 - 16—Frame automatically turns off after 16 hours (default).
 - 24—Frame plays continuously. Press the power button to turn it off.

4

Appendix

Digital frame specifications

For more specifications, visit www.kodak.com/go/digitalframesupport.

KODAK EASYSHARE D825 / D1025 Digital Frame / Decor Series	
Color display	D825: 8 in. (20.3 cm) diagonal digital LCD, 800 x 600 pixels, 4:3 aspect ratio, 6.4 x 4.8 in. (16.2 x 12.2 cm) active area D1025: 10.4 in. (26.4 cm) diagonal digital LCD, 800 x 600 pixels, 4:3 aspect ratio, 8.3 x 6.2 in. (21.1 x 15.8 cm) active area
Internal storage capacity	D825/D1025: 512 MB
Power supply	D825: Manufacturer, Model #: Malata MPA-05015, EIAJ class 2 DC plug Input: 100-240V AC 50/60 Hz. Output: 5V DC 1.5 Amp (Default, frame turns off after 16 hours, see page 22)
Communication with USB devices	USB 2.0 High Speed Type A
Picture formats	JPEG, EXIF 2.2
Memory cards see page 5	Top card slot: SD (SECURE DIGITAL); MMC (MULTIMEDIA Card); XD; MS (MEMORY STICK) Bottom card slot: MS (MEMORY STICK)/MS Pro Duo
Temperature	Operating: 32 to 104° F (0 to 40° C) Storage: -25 to 160° F (-32 to 71° C)
Size (w/o faceplate)	D825: 7.9 x 10 x 1.4 in. (25.3 x 20.2 x 3.5 cm) D1025: 8 x 10 x 1.2 in. (20.2 x 25.4 x 3.0 cm)
Weight (w/o faceplate)	D825: 1.9 lb. (843 gm) includes frame, stand, and AC adapter D1025: 2.0 lb. (878 gm) includes frame, stand, and AC adapter

Important safety instructions

CAUTION:

Do not disassemble this product; there are no user-serviceable parts inside. Refer servicing to qualified service personnel. KODAK AC Adapters and Battery Chargers are intended for indoor use only. The use of controls, adjustments, or procedures other than those specified herein may result in exposure to shock and/or electrical or mechanical hazards. If the LCD breaks, do not touch the glass or liquid. Contact Kodak customer support.

- The use of an accessory that is not recommended by Kodak may cause fire, electric shock, or injury. For approved accessories, visit www.kodak/go/accessories.
- Use only the AC adapter that was packaged with your frame. Use of other AC adapters may damage the frame and void your warranties.
- Do not place frame near open flame sources such as lighted candles or heaters.
- Do not expose this product to liquid, moisture, or extreme temperatures.

Additional care and maintenance

- To clean the frame or screen, use a soft, lint-free cloth dampened with lens cleaning solution or a water-based cleaning solution. Use light pressure.
- Do not allow chemicals, such as suntan lotion, to contact painted surfaces.
- Service agreements are available in some countries. Contact a dealer of Kodak products for more information.
- For digital frame disposal or recycling information, contact your local authorities. In the US, visit the Electronics Industry Alliance at www.eiae.org or visit www.kodak.com/go/digitalframesupport.

Limited warranty

Kodak warrants Kodak consumer electronic products and accessories ("Products"), excluding batteries, to be free from malfunctions and defects in both materials and workmanship for one year from the date of purchase. Retain the original dated sales receipt. Proof of the date of purchase will be required with any request for warranty repair.

Limited warranty coverage

Warranty service is only available from within the country where the Products were originally purchased. You may be required to ship Products, at your expense, to the authorized service facility for the country where the Products were purchased. Kodak will repair or replace Products if they fail to function properly during the warranty period, subject to any conditions and/or limitations stated herein. Warranty service will include all labor as well as any necessary adjustments and/or replacement parts. If Kodak is unable to repair or replace a Product, Kodak will, at its option, refund the purchase price paid for the Product provided the Product has been returned to Kodak along with proof of the purchase price paid. Repair, replacement, or refund of the purchase price are the sole remedies under the warranty. If replacement parts are used in making repairs, those parts may be remanufactured, or may contain remanufactured materials. If it is necessary to replace the entire Product, it may be replaced with a remanufactured Product. Remanufactured Products, parts and materials are warranted for the remaining warranty term of the original Product, or 90 days after the date of repair or replacement, whichever is longer.

Limitations

This warranty does not cover circumstances beyond Kodak's control. This warranty does not apply when failure is due to shipping damage, accident, alteration, modification, unauthorized service, misuse, abuse, use with incompatible accessories or attachments (such as third party ink or ink tanks), failure to follow Kodak's operation, maintenance or repacking instructions, failure to use items supplied by Kodak (such as adapters and cables), or claims made after the duration of this warranty. Kodak makes no other express or implied warranty for this product, and

disclaims the implied warranties of merchantability and fitness for a particular purpose. In the event that the exclusion of any implied warranty is ineffective under the law, the duration of the implied warranty will be one year from the purchase date or such longer period as required by law. The option of repair, replacement, or refund is Kodak's only obligation. Kodak will not be responsible for any special, consequential or incidental damages resulting from the sale, purchase, or use of this product regardless of the cause. Liability for any special, consequential or incidental damages (including but not limited to loss of revenue or profit, downtime costs, loss of the use of the equipment, cost of substitute equipment, facilities or services, or claims of your customers for such damages resulting from the purchase use or failure of the Product), regardless of cause or for breach of any written or implied warranty is expressly disclaimed.

Your rights

Some states or jurisdictions do not allow exclusion or limitation of incidental or consequential damages, so the above limitation or exclusion may not apply to you. Some states or jurisdictions do not allow limitations on how long an implied warranty lasts, so the above limitation may not apply to you. This warranty gives you specific rights, and you may have other rights which vary from state to state or by jurisdiction.

Outside the United States and Canada

In countries other than the United States and Canada, the terms and conditions of this warranty may be different. Unless a specific Kodak warranty is communicated to the purchaser in writing by a Kodak company, no warranty or liability exists beyond any minimum requirements imposed by law, even though defect, damage, or loss may be by negligence or other act.

Regulatory compliance and advisory

FCC compliance and advisory

This equipment has been tested and found to comply with the limits for a Class B digital device, pursuant to Part 15 of the FCC Rules. These limits are designed to provide reasonable protection against harmful interference in a residential installation. The equipment generates, uses, and can radiate radio frequency energy and, if not installed or used in accordance with the instructions, may cause harmful interference to radio communications. However, there is no guarantee that interference will not occur in a particular installation. If this equipment does cause harmful interference to radio or television reception, which can be determined by turning the equipment off and on, the user is encouraged to try to correct the interference by one or more of the following measures: 1) reorient or relocate the receiving antenna; 2) increase the separation between the equipment and the receiver; 3) connect the equipment to an outlet on a circuit different from that to which the receiver is connected; 4) consult the dealer or an experienced radio/TV technician for additional suggestions. Any changes or modifications not expressly approved by the party responsible for compliance could void the user's authority to operate the equipment. Where shielded interface cables have been provided with the product or specified additional components or accessories elsewhere defined to be used with the installation of the product, they must be used in order to ensure compliance with FCC regulation.

Canadian DOC statement

DOC Class B Compliance—This Class B digital apparatus complies with Canadian ICES-003.

Observation des normes-Classe B—Cet appareil numérique de la classe B est conforme à la norme NMB-003 du Canada.

CE

Hereby, Eastman Kodak Company declares that this Kodak Product is in compliance with the essential requirements and other relevant provisions of Directive 1999/5/EC.

Licensing

Supply of this product does not convey a license nor imply any right to distribute content created with this product in revenue-generating broadcast systems (terrestrial, satellite, cable and/or other distribution channels), streaming applications (via Internet, intranets and/or other networks), other content distribution systems (pay-audio or audio-on-demand applications and the like) or on physical media (compact discs, digital versatile discs, semiconductor chips, hard drives, memory cards and the like). An independent license for such use is required. For details, please visit <http://mp3licensing.com>.

Australian C-Tick



N137

Waste Electrical and Electronic Equipment labeling



In Europe: For human/environmental protection, it is your responsibility to dispose of this equipment at a collection facility established for this purpose (separate from municipal waste). For more information, contact your retailer, collection facility, or appropriate local authorities; or visit www.kodak.com/go/recycle.

Product weight with adapter and stand: D825, 843 gm. / D1025, 1429 gm.

Russian GOST-R



Eastman Kodak Company
Rochester, New York 14650

Фотокамера изготовлена в Китае; остальные элементы -
в соответствии с маркировкой.

ENERGY STAR Product



ENERGY STAR[®] qualified product.

VCCI Class B ITE

この装置は、情報処理装置等電波障害自主規制協議会（VCCI）の基準に基づくクラスB情報技術装置です。この装置は、家庭環境で使用することを目的としていますが、この装置がラジオやテレビジョン受信機に近接して使用されると、受信障害を引き起こすことがあります。

取扱説明書に従って正しい取り扱いをして下さい。

Korean Class B ITE

B급 기기
(가정용 방송통신기기)

이 기기는 가정용(B급)으로 전자파적합등록을
한 기기로서 주로 가정에서 사용하는 것을 목적
으로 하며, 모든 지역에서 사용할 수 있습니다.

China RoHS

Product Disclosure Table
KODAK Digital Picture Frames
有毒有害物质或元素名称及含量标识表
table of hazardous substances' name and concentration

部件名称 Component name	有毒有害物质或元素 hazardous substances' name					
	铅 (Pb)	汞 (Hg)	镉 (Cd)	六价铬 (Cr6+)	多溴联苯 (PBB)	多溴二苯醚 (PBDE)
交流变压器电路板元件 AC Adapter circuit board components	x	o	o	o	o	o
数码相架电路板元件 Digital Photo Frame circuit board components	x	o	o	o	o	o
数码相架外壳 Digital Photo Frame Enclosure	o	o	o	o	o	o
○：表示该有毒有害物质在该部件所有均质材料中的含量均在SJ/T 11363-2006规定的限量要求以下。 ×：表示该有毒有害物质至少在该部件的某一均质材料中的含量超出SJ/T 11363-2006规定的限量要求。 ○：indicates hazardous substance concentration lower than MCV ×：indicates hazardous substance concentration higher than MCV						

Index

A

- AC adapter
 - attaching, 3
 - safety information, 24
 - specifications, 23
- appendix, 23
- attaching
 - different standard frame, 6

B

- By date play order, 13

C

- cable
 - power, connecting, 3
 - USB, connecting, 5
- card, memory
 - inserting, 5
 - slot, ii
 - supported types, 23
 - viewing pictures from, 11
- cleaning frame, 17, 24
- copying to internal memory, 14

D

- delete pictures, 16
- disposal, recycling, 24
- download firmware, 21
- duration, changing, 13

E

- energy saver, 22

energy star, 29

error icons, 20

F

- file formats, supported, 23
- firmware, upgrading, 21
- flash drive
 - connecting, 5
 - viewing pictures from, 11
- frame, picture
 - resetting, 18
 - specifications, 23
 - troubleshooting, 18
 - turn on/off, 4
- freeze or lock screen, reset, 18

G

- graphic messages, 19

H

- help
 - frame, 18
 - support URLs, 17
 - troubleshooting and support, 17

I

- icons, screen, 19
- inserting
 - memory cards, 5
 - USB device, 5
- installing
 - standard picture frame, 6, 8, 9, 10

internal memory
 capacity, 23
 copying into, 14
 playing from, 11

L

locked screen, reset, 18

M

memory card. See card, memory
messages on screen, 19, 20

N

navigating through pictures, 12
next play, 12

P

pictures
 copying to internal memory, 14
 deleting, 16
 navigating through, 12
 playback speed, 13
 sample, pre-loaded, 11
 viewing, 11
play by date, 13
play/pause button, 12
playing pictures, 11
power
 button, 4
 connecting, 3
power supply, specifications, 23
previous play, 12

R

recycling, disposal, 24

regulatory compliance, 27
reset frame, 18

S

safety information, 24
screen
 cleaning, 17, 24
 error icons, 20
 settings, changing, 13
 shuffle play, 13
 specifications, frame, 23
 speed, changing play, 13
 stand, attaching, 1, 2
 standard picture frame, adding, 6
 storage capacity, internal memory, 23

T

thumb drive. See flash drive.
transitions, changing, 13
troubleshooting
 error messages, 20
 frame, 18
turn on frame, 4

U

upgrade firmware, 21
USB
 device, connecting, 5
 type, 23

W

warranty, 25
Web sites, help, 17