Kodak EasyShare wireless digital picture frame



User's guide

for EX811, EX1011

www.kodak.com

For help with your picture frame, www.kodak.com/go/digitalframesupport

Kodak

Eastman Kodak Company
Rochester, New York 14650

© Eastman Kodak Company, 2007

All screen images are simulated.

Kodak and EasyShare are trademarks of Eastman Kodak Company.

Eastman Kodak Company is an authorized licensee of the CompactFlash trademark.

P/N 2F6846_en

Front View

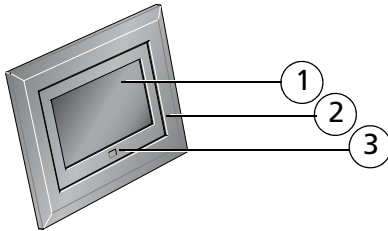

- 1 LCD screen
- 2 Faceplate
- 3 Remote control sensor

Back/Left Side View

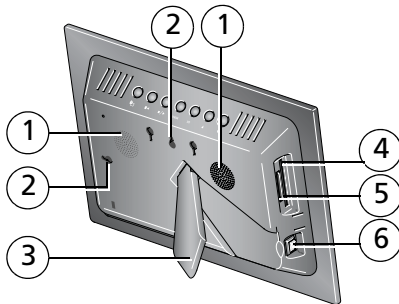

- 1 Speakers
- 2 Wall mount hangers
- 3 Frame stand
- 4 Memory card slot - CF, MD
- 5 Memory card slot - SD, MS, xD, MMC
- 6 On/Off switch
- 7 Remote control holder (removable)

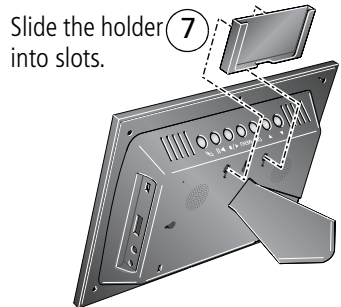

Top/Right Side View

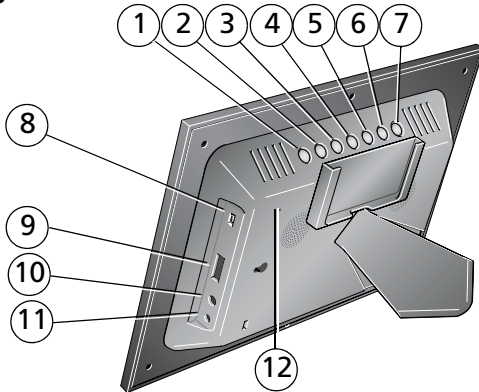





- | | |
|--|---|
| 1 Picture/music toggle  | 8 USB connector (to connect to computer; also connect camera/USB device - with adapter cable.) |
| 2 Play/Pause  | 9 Volume control |
| 3 Stop/Back  | 10 Headphone jack  |
| 4 Menu | 11 DC-In (12 V)  |
| 5 OK | 12 Reset button |
| 6 Down ▼ | |
| 7 Up ▲ | |

Table of contents

1 Getting started	1
Installing the software.....	1
Using the remote control.....	1
Setting up your picture frame	4
2 Viewing pictures and videos	8
Home screen—picture sources and settings.....	8
Running a slide show	9
Viewing thumbnails	9
Viewing a single picture	10
Playing a video.....	10
Viewing pictures by date or filename	11
3 Doing more with your frame	12
Playing music.....	12
Printing pictures.....	13
Copying on your frame	14
Copying between your frame and computer.....	15
Deleting pictures/videos	16
Selecting multiple pictures/videos	17
4 Changing frame settings	18
Settings menus	18
Setting the clock and timer.....	20
Upgrading your firmware.....	22
5 Using wireless mode	24
What are the wireless features of my frame?	24
Setting up your frame for wireless operation	24
Wireless networking and the Internet	24
Viewing pictures over your wireless network	25

Viewing pictures from the KODAK Gallery.....	26
Automatically receiving My Friends' Albums.....	27
Picture transfer software—copying wirelessly	29
Glossary of common wireless network terms.....	31
6 Troubleshooting and support	35
Picture frame problems	35
Picture frame/computer communications	35
Wireless network connection	36
Screen messages.....	39
7 Appendix	41
Digital frame specifications.....	41
Important safety instructions	43
Upgrading your software and firmware	44
Additional care and maintenance	44
Limited warranty.....	45
FCC compliance and advisory	47

1

Getting started

Welcome to your Kodak EasyShare digital picture frame. Viewing your pictures and videos couldn't be simpler!

Installing the software

See the *Wireless Setup Guide* to install the software and to set up your frame and wireless network.

Using the remote control

Activating the remote control

An activation tab protects the remote control's battery during shipment.

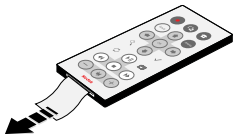

- Remove the tab to start using the remote.

There is no need to open the battery compartment or remove the battery.

Storing the remote control

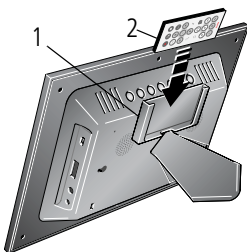

- 1 Install the remote control holder on the back of the frame ([page i](#)).
- 2 Slide the remote into the holder for convenient, out-of-the-way storage.

Replacing the remote control battery

NOTE: Replace with a CR2025, 3V lithium cell battery.

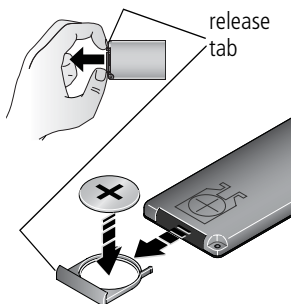

- 1 Push and hold the release tab while pulling the battery holder out of the remote. Follow the graphic on the back of the remote control.
- 2 Place the new battery in the holder with the plus sign (+) facing up as shown.
- 3 Slide the battery and holder into the remote until it clicks into place.

Using the remote control buttons

Some buttons are also on the back of the frame ([page ii](#)). They operate identically.

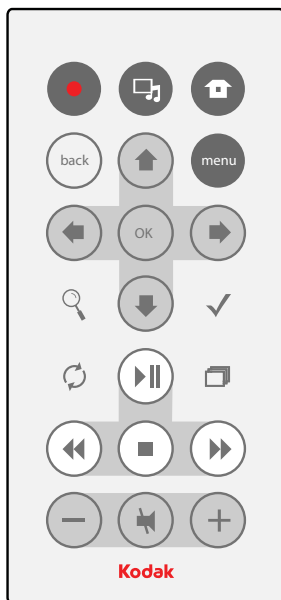



Button	Press to:
	power* turn on/off the picture frame.
	home return to the home screen.
	music/pics toggle between viewing pictures and selecting music.
	menu display the menu choices.
	back return to the previous screen. stop a slide show, display thumbnails.
	OK accept the current selection.
	4-way navigate through pictures or menus.
	zoom magnify the picture.
	rotate rotate the picture, 90° clockwise each press.
	select mark pictures for an operation.
	slide show play a slide show.
	play/pause play/pause a video or slide show.
	rewind rewind a video.
	fast forward fast forward a video.
	stop stop a video, display the first frame. stop a slide show, display thumbnails.
	volume decrease (-) or increase (+) the volume.
	mute mute audio.

* First, turn on the power switch on the frame.

Setting up your picture frame

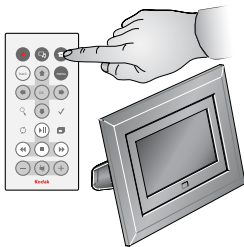
Buttons and controls



All buttons and controls described in this guide (for example: press ) are on the remote control unless otherwise noted.

Connecting the power cable

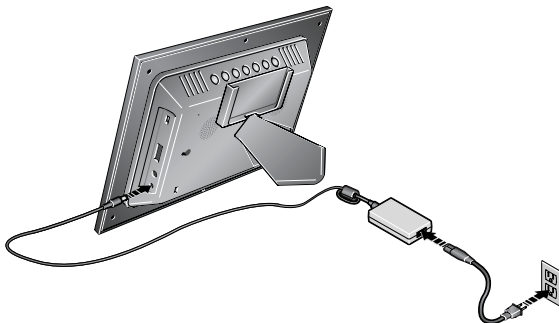

- 1 Pull out and extend the stand on the frame back and place the frame on a flat, stable surface.
- 2 Plug in the power cable.

Your power cable (included with the frame) may be different from the one pictured. Use the plug that accommodates your type of power outlet.

Inserting a card or camera

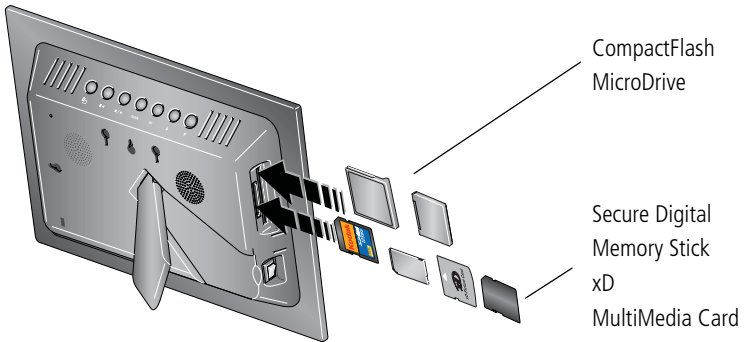

Connecting a digital camera or other USB device

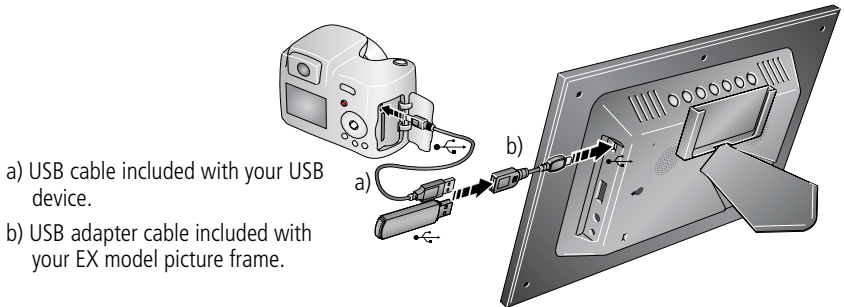

Turning on the frame

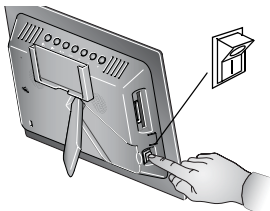

- Press the power switch to On.

NOTE: You can leave the power switch On, and use the remote control to turn the frame off and on.

Setting your language





The language screen appears the first time you turn on your frame.

- Press  to select your language, then press OK.

A slide show starts from sample pictures pre-loaded in internal memory.

- To change the language at a later time, press Home

 , Settings  → Language. See [page 20](#).

Viewing your first slide show!





- To play a slide show, insert a memory card or USB device (see [page 5](#)).

The pictures/videos are displayed in the order they appear on the card or other device.





- If a slide show is already playing (for example, from the pre-loaded sample pictures), your pictures begin playing automatically.
- If you are at the Home screen, press ◀▶ to highlight your picture source, then press  to start the slide show.

- To play music  with your pictures or slide shows, see [page 12](#).
- To view pictures from your computer over your wireless network, see [page 25](#). For setting up your network, see the *Wireless Setup Guide*.

Changing the frame orientation

Your frame is set up to display pictures in landscape orientation . You can turn it to portrait  but you must also change the setting. Here's how.



- 1 Press Home , Settings .
- 2 Press  to select Viewing options, then press OK.
- 3 Press  to select Frame orientation, then press OK. See [page 19](#).





2

Viewing pictures and videos

Home screen—picture sources and settings

Go to the Home screen to access pictures from all connected sources and to change frame settings.



- 1 On the remote control, press Home  .
All connected sources and the Settings icon are displayed.
- 2 Press   to highlight a picture source, then:
 - Press  to start a slide show.
 - Press OK to display thumbnails, folders, albums.

Possible picture sources:



My Frame—the frame's internal memory. Copy your special pictures into My Frame from a memory card or other device ([page 14](#)).



Memory card—appears when you insert a card ([page 5](#)). The label and icon indicate the type of card.



Camera—appears when you connect a digital camera via USB cable ([page 5](#)).



USB drive—appears when you insert a USB flash drive ([page 5](#)).



Network computer—appears if you are connected to a wireless network. Lets you display pictures that are stored on your computer. See the *Wireless Setup Guide* or Chapter 5 in this guide.



Kodak Gallery—appears if you have set up your Gallery account and are connected to a wireless network. Lets you display your albums from the Gallery. See the *Wireless Setup Guide* or Chapter 5 in this guide.



Kodak Gallery, with new picture notification —someone has shared pictures with you at the Gallery! See [page 27](#).



Settings—customize and configure your frame. See [Changing frame settings](#), page 18.

Running a slide show

There are three ways to start a slide show on your frame:

- Insert a memory card or connect a USB device, then turn on the frame.
- Turn on your frame, then insert a card or connect a USB device—a new slide show starts automatically, replacing a currently running slide show or single view picture.
- Select a picture in thumbnail view or select a picture source on the Home screen, then press **▶||** or **🖼️**.

Other slide show information

- A slide show plays continuously until you stop it or turn off the frame.
- You can change the slide duration and transition style (see [page 19](#)).

Viewing thumbnails





There are two ways to view your pictures as thumbnails:



- Press **🏠**, select a picture source (see [page 8](#)), then press OK.
- Press **■** or **back** from a slide show or single view.





To navigate through the thumbnails, press **⬅➡⬆⬇➤**.

Viewing a single picture

- To view a single, full-screen picture, highlight it in thumbnails view and press OK.
- To magnify a picture up to 8X, press  repeatedly. To view other parts of the picture, press . Press  repeatedly to return.
- To rotate a picture, press .

Playing a video

- To play a video from thumbnails view, highlight it and press OK.
- Videos in thumbnail view:
 - MOV videos are indicated with .
 - AVI, MPEG, and MPG videos display the first frame.
- During a slide show, videos play automatically. When the video ends, the slide show resumes.
- Video buttons on the remote control:

Press	To
	play, pause, and resume the video.
	rewind / fast forward.
	adjust the volume.
 or back	stop the video and return to thumbnails.

Viewing pictures by date or filename

By default, the pictures and videos on your frame are arranged and played by date, starting with the oldest. You can change the arrangement, or sort order, by date or alphabetically by filename.

To change the sort order:

- 1** Press **menu**, then select **Sort by**.
- 2** Press **OK**.
- 3** Select a sort order:
 - Date, oldest to newest (default)
 - Date, newest to oldest
 - Filename, A to Z
 - Filename, Z to A
- 4** Press **OK**.

3

Doing more with your frame

Playing music

Play your MP3 files from any connected source (see [page 8](#)).

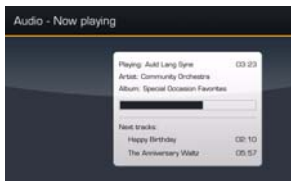

1 Press .

Your picture or slide show is paused.

2 Press  to highlight your music source, then press OK.

3 Press  to locate your music files, then press OK.

4 Press  to go to the next or previous song, or select Play all songs. Then press OK.

Your music starts playing.



5 Press  to return to your picture or slide show.

Your selected music continues to play as the slide show resumes. When music is playing, videos play without their related audio.

6 To turn off music, press , then .

7 Press  again to return to your pictures.

Notes on playing and copying music:

- A headphone jack is available on the side of the frame ([page ii](#)).
- Adjust the volume with the   buttons. Press  to mute the music.
- To copy music files (MP3) to internal memory, drag and drop them from your computer. See [Copying pictures to/from your computer, page 15](#).

Printing pictures

Your frame is compatible with PictBridge technology, so you can print directly to PictBridge enabled printers.

NOTE: Printing from the Gallery ([page 26](#)) is not currently supported.

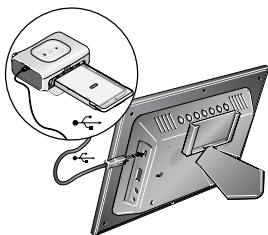

Preparing the frame and printer for printing



- 1 Make sure your frame is disconnected from the printer.
- 2 On the frame, change your connection mode from computer to printer. See [Manually changing USB connection mode, page 14](#).
- 3 Turn off the frame and printer.
- 4 Connect the USB cable (included with your frame) from the frame to the printer.



Printing to a PictBridge enabled printer



- 1 Turn on the printer. Turn on the frame.
- 2 If you are in a slide show or single view, press . If you are in thumbnails view, press  to find a picture, then press .
- 3 Highlight Print, press OK, then highlight Print again, and press OK
The picture is printed. To print multiple pictures, see [page 17](#).
- 4 Change your connection mode back to Connect to computer. See [Manually changing USB connection mode, page 14](#).

Manually changing USB connection mode





The connection mode must match the device you connect the frame to (computer or printer) before you make the connection. The default is Connect to computer.

- 1 Disconnect the printer or computer from the frame.
- 2 On the remote control, press .
- 3 Select Settings  → Device configuration → USB connection mode.
- 4 Select the mode you need, printer or computer. See [page 20](#).
- 5 Reconnect the printer or computer. If you are printing, continue with step 3 of the printing directions in [Printing to a PictBridge enabled printer, page 13](#).

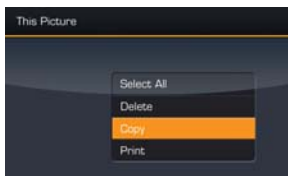
Copying on your frame

Copy pictures/videos from your current picture source to any other connected device or source. For example, copy pictures from a memory card to internal memory (My Frame).



- 1 Press  to find a picture/video, then press .
- 2 Press  to highlight Copy, then press OK.
- 3 Press  to highlight the source you want to copy to, then press OK.

The picture/video is copied.

To copy multiple pictures/videos, [see page 17](#).

When you copy pictures into internal memory, they are automatically resized to save space on your frame. To turn off automatic resizing, see [page 20](#).

NOTE: To copy music files (MP3) to your frame's internal memory, drag and drop them from your computer. See [Copying pictures to/from your computer, page 15](#).

Copying between your frame and computer

Copy pictures, videos, and music via the included USB cable. For wireless copying, see [page 29](#).

Connecting to your computer

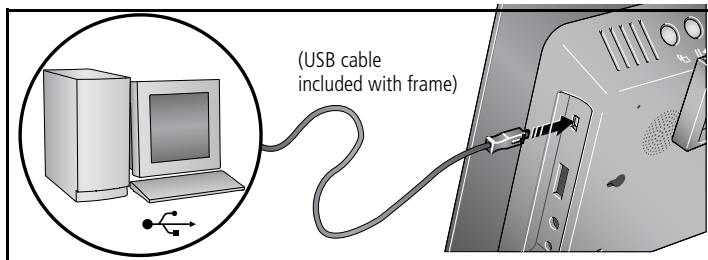

Copying pictures to/from your computer

Copy pictures, videos, and music between your frame and computer, using your computer's normal file copying tools. See [page 41](#) for applicable file formats.

- 1 Connect the USB cable from the frame to your computer ([see page 15](#)).
- 2 On your computer, open My Computer or Windows Explorer.

The picture frame appears as removable drives—one drive for each connected picture source in the frame, in this order: internal memory, memory cards, USB devices.
- 3 Navigate to the pictures you want to copy. Then drag and drop them to the new location.
- 4 Unplug the USB cable to view your copied pictures.

See your computer documentation for more information on copying files.

Copying pictures from EasyShare software

It's easy to copy pictures/videos from My Collection to your frame.



- 1 Install EasyShare software from the CD included with your frame (see page 1).
- 2 Connect the USB cable (see page 15).
- 3 On your computer, open EasyShare software. Select the pictures in My Collection and drag them into the Picture tray.
- 4 In the menu bar, select File → Copy to.

The picture frame appears as removable drives—one drive for each connected picture source in the frame, in this order: internal memory, memory cards, USB devices.

- 5 Select the frame source to which you are copying.
- 6 Select *Best For Digital Picture Frame* to reduce the resolution of the pictures you are copying. Full resolution is unnecessary and quickly fills up the frame's memory.
- 7 Click Copy. Pictures are copied to your frame.
- 8 Unplug the USB cable and press  to navigate to your copied pictures.

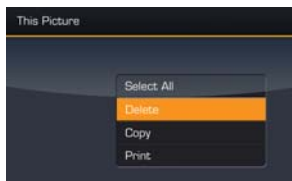
Deleting pictures/videos



- 1 Press  to find a picture/video, then press .
- 2 Press  to highlight Delete, then press OK.
- 3 Highlight Delete and press OK again to confirm. To cancel the deletion, highlight Exit and press OK.

The picture/video is deleted.

To delete multiple pictures/videos, see page 17.

NOTE: You can delete pictures/videos from a card, internal memory, and some USB devices.

Selecting multiple pictures/videos

Use the multi-select feature to copy, delete, or print two or more pictures; or to play a slide show of selected pictures/videos.

Selecting one at a time

- 1 In thumbnails view, press **←** **↑** **→** to highlight a picture/video, then press **✓**.
- 2 Continue selecting pictures/videos.

*A check mark appears on the selected pictures. Press **✓** again to remove a check mark. You can now view a slide show, copy, print, delete, etc. all selected pictures.*

Selecting all



- 1 Press **(menu)** whenever pictures/videos are displayed (slide show, video, single picture).

- 2 Press **↑** to highlight Select all, then press OK.

A confirmation screen appears, then your picture display reappears. A check mark is displayed on all pictures/videos in your current location.

- 3 To remove all check marks, press **(menu)**, highlight Select / Unselect all and press OK.







- 4 Highlight Unselect all and press OK.

A confirmation screen appears, then your picture display reappears. All check marks are removed.

4





Changing frame settings

The options in the Settings menu let you customize and configure your frame.

- 1 Press Home  .
- 2 Press   to highlight Settings , then press OK.
- 3 Press   to select a setting. Follow the screen directions. Press OK to accept your selections.
- 4 Press  to exit.

Settings menus





Setting	Options
Upgrade firmware This option is only displayed if the upgrade file (.img) is available on the frame (memory card, flash drive, internal memory, etc.).	Upgrade firmware —manually load the latest version of firmware on your frame (page 22). Exit —return to the Home screen. See page 23 for automatic notification and upgrade of latest firmware from the Internet.

Setting	Options
Viewing options	<p>Slide duration—specify how long each picture is displayed in a slide show, from 3 seconds (default) to 1 hour.</p> <p>Frame orientation—specify whether you wish to display your frame in landscape (default)  or portrait  orientation.</p> <p>Transitions—specify the transition style between pictures in a slide show. See screen for options. The default is Random.</p> <p>Screen Fit or Fill—Fit entire image  (default). Show the entire picture. Black borders may appear around the image. Fill the screen . The picture fills the entire screen, some of the picture may be cut off (cropped).</p> <p>Audio priority—when you are playing music (page 12), choose how to handle the audio portion of video playback. Play music (default). Music continues to play, video plays but its audio is muted. Play video sound track. Music stops playing while the video, with audio, plays.</p> <p>Slideshow starting point—specify how far back to start a slide show when your sort order is from oldest to newest (page 11). From 1 week back (default). Slide show starts with the picture that is one week older than the newest picture in your current picture source. From oldest picture. Slide show starts with the oldest picture in your current picture source.</p>
Brightness	Press ◀ ▶ to adjust the screen brightness according to your lighting conditions.
Clock and timer See page 20.	<p>On/Off schedule—set your frame to turn on and off at a specified time every day.</p> <p>Get time from Internet—select your time zone and press OK. The frame's internal clock is automatically set to the correct time.</p> <p>Set time—manually set the clock to the current time.</p>





Setting	Options
KODAK Gallery	Set up your Kodak Gallery account on the frame. See the <i>Wireless Setup Guide</i> .
Network	Set up your frame for wireless operation. See the <i>Wireless Setup Guide</i> .
Device configuration	Frame name —Assign a name to your frame. This name is referenced when connecting to your wireless network. USB connection mode —Before you connect a USB computer or printer, choose Connect to computer (default) or Connect to printer . See page 14 .
Language	Choose your language.
Automatic resizing	Automatic resizing ON —(default) When you copy pictures to internal memory, they are automatically resized to a smaller resolution to save space. Automatic resizing OFF —Pictures are copied to internal memory at their original size (resolution).
About	Check your frame model number and firmware version.

Setting the clock and timer

Setting the clock manually

- 1 Press Home , then select Settings  and press OK.
- 2 Select *Clock and timer* and press OK.
- 3 Select *Set time* and press OK.
- 4 Press  to adjust the hour and minutes. Press  to highlight the next or previous setting.
- 5 Press OK. Press Home  to return to the Home screen.

Setting the clock automatically from the Internet







- 1 Press Home , then select Settings  and press OK.
- 2 Select *Clock and timer* and press OK.
- 3 Select *Get time from Internet* and press OK.
- 4 Press  to highlight Enable, then press OK.
- 5 Press  to highlight your time zone, then press OK. Press Home  to return to the Home screen.

The frame clock is automatically set whenever you are connected to the Internet through your wireless network.

Setting automatic on/off

Set your frame to turn on and off at a specified time every day.

NOTE: Make sure you set the clock or enable *Get time from Internet* before enabling auto on/off.

- 1 Press Home , then select Settings  and press OK.
- 2 Select *Clock and timer* and press OK.
- 3 Select *On/Off schedule* and press OK.
- 4 Press  to advance to *Turn on* time. Press  to highlight the next or previous setting (hour and minutes). Press  to adjust the time. Repeat to set the *Turn off* time.
- 5 Press  to highlight Enable, then press OK. Press Home .

Your frame will now automatically turn on and off at the times you specified.

NOTE: Make sure the power switch on the frame is On .



Upgrading your firmware

Firmware is the software that runs on your frame. Upgrade the firmware so you always have the newest features and improvements. To check for the latest version, visit www.kodak.com/go/digitalframedownloads.

NOTE: Upgrading the firmware returns the frame settings to factory defaults.

Manually upgrade firmware

Download the firmware to your computer, then upgrade your frame:

- 1 On your computer, go to www.kodak.com/go/digitalframedownloads.
- 2 Follow the screen directions to download the frame firmware to your computer.
- 3 Copy the IMG file to a memory card or USB flash drive, then insert into the frame; or, connect your computer and frame with the USB cable and copy the IMG file directly to the frame. See [page 15](#) for copying files.
- 4 With the IMG file on the frame, press Home , then select Settings  and press OK.
- 5 Select Upgrade Firmware and press OK to begin the upgrade.

When the upgrade is complete, your frame automatically restarts. If it doesn't, press the power switch on the frame to Off, then back to On.

IMPORTANT: *Do not turn off the frame during the upgrade!*

Automatically upgrade firmware from the Internet

When the frame is connected to your wireless network, you can automatically upgrade the firmware from the Internet whenever a new version is available.

A message appears on your frame when a new firmware version is detected from the Internet.

Upgrade right away

- **Install now**—Select, then press OK to start the upgrade.

When the upgrade is complete, your frame automatically restarts. If it doesn't, press the power switch on the frame to Off, then back to On.

IMPORTANT: *Do not turn off the frame during the upgrade!*

Upgrade later

- **Remind me later**—Select, then press OK.

The upgrade message disappears, then appears again the next time you turn on the frame.

- **No thanks**—Select, then press OK.

The upgrade message disappears. To change your mind and upgrade to this version, see [Manually upgrade firmware, page 22](#).

A new message appears when the next firmware version is available.

For more information on wireless setup, operation, and networks, see the *Wireless Setup Guide* (included with EX model frames only) or visit www.kodak.com/go/wifisupport or www.wi-fi.org.

What are the wireless features of my frame?

Connect to your home wireless network and:

- Display pictures on your frame directly from your computer hard drive (see [page 25](#)).
- Display pictures from your *Kodak Gallery* account (see [page 26](#)).
- Automatically receive pictures from your friends and family at the Gallery (see [page 27](#)).
- Automatically upgrade your firmware from the Internet (see [page 23](#)).
- Copy pictures wirelessly from your frame to your computer (see [page 29](#)).

Setting up your frame for wireless operation

See the *Wireless Setup Guide*, included with your frame, for detailed instructions on installing software and setting up your frame.

Do you have security enabled on your wireless network? If so, have your network name and security key (WEP or WPA) available.

Wireless networking and the Internet



Some wireless functions on your frame, including viewing pictures on *Kodak Gallery* (see [page 26](#)), require access to the Internet.

Viewing pictures over your wireless network

Pictures are accessed from your computer via Windows Media player 11. See the *Wireless Setup Guide* for details about installing or upgrading to Windows Media player 11.

- 1 Turn on your computer and your picture frame. Then press Home  on the remote control.



- 2 Press   to highlight Network Computer , then press OK.

It may take up to 10 seconds for your Network Computer to appear on the Home screen.

If you have multiple computers on your network, first select Network Computer, then select the computer from the list.

If your network computer is not listed on the Home screen, or for more information, see the *Wireless Setup Guide* or go to the troubleshooting help on [page 36](#) of this guide.

NOTE: The first time you connect, a window may appear on your computer screen alerting you to a new device. Follow the prompts to “allow” the frame on your computer (see [page 30](#)).



- 3 Press   to highlight Pictures or Video, then press OK.



- 4 Press  to highlight the category of pictures you want to view, then press OK.

All Pictures displays every picture that your computer is sharing, without showing folders. The categories are established by Windows Media player 11; you designate pictures to include in the categories (in Windows Media player).





- 5 Pictures are displayed as thumbnails. See [Chapter 2, Viewing pictures and videos](#) for all the ways you can enjoy your pictures, videos, and music on your frame.

Viewing pictures from the KODAK Gallery

See the *Wireless Setup Guide* for detailed instructions on setting up your Kodak Gallery connection.

NOTE: Connection to Kodak Gallery is currently limited to customers in the United States, Canada, and Europe.

- 1 Turn on your computer and your picture frame, and make sure your Internet connection is live.
- 2 Press Home , press  to highlight Kodak Gallery , then press OK.
- 3 Follow the prompts to choose the pictures, then press OK.
- 4 Pictures are displayed as thumbnails. See [Chapter 2 on page 8](#) for all the ways you can enjoy your Gallery pictures on your frame.

NOTE: Features not supported from the Gallery at this time: viewing videos, printing pictures, and deleting pictures.

Automatically receiving My Friends' Albums

Your wireless frame automatically notifies you when a friend shares pictures with you at the Gallery. Play a slide show of the new pictures, right on your frame, even before you see the email on your computer! To turn off the auto-notification, see [page 28](#).



NOTE: The email icon  means you have new pictures that you haven't viewed yet.

To see the pictures right away:

- 1 When the notice  appears on the frame screen, press   to highlight View.
- 2 Press OK.

A slide show of the new pictures plays on your frame. If there are multiple albums you haven't viewed yet, select a marked album  from the list and press OK.

To see the pictures later:

- 1 When the notice appears on the frame screen, highlight Dismiss, then press OK.
The notification bar disappears. (If you don't dismiss it, the bar automatically disappears after 30 seconds.)
- 2 When you want to see the new pictures, press Home (), select KODAK Gallery (), then press OK.
- 3 With My Friends' Albums highlighted, press OK.
- 4 Highlight a marked album , then press OK.

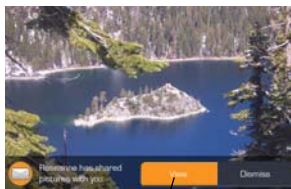

View





Dismiss





Turning off auto-receive and notification

You can turn off auto-receive and/or notification from your friends' albums at the Gallery.

- 1 Press Home , then select Settings  and press OK.
- 2 Select KODAK Gallery and press OK.
- 3 Press  to highlight Auto-receive My Friends' Albums, then press OK.
- 4 Choose from these options:

Auto-receive with notification ON—(default) you automatically receive your friends' albums and the notice appears on the frame.





Auto-receive ON—you automatically receive your friends' albums, but the notice does not appear on the frame. You know when your friends send you pictures because the email icon still appears on the KODAK Gallery on the Home screen , and on unviewed My Friends' Albums in your Gallery account .

Auto-receive OFF—you don't automatically receive your friends' albums on your frame. To view them, see [Viewing pictures from the KODAK Gallery, page 26](#).

Picture transfer software—copying wirelessly

Kodak picture transfer software (included on the software CD packaged with your EX model frame) lets you wirelessly copy pictures and videos from the frame to your computer. Make sure you install the software before you proceed (see the *Wireless Setup Guide*).

Copying to your computer

- 1 On the frame, display a picture in single view (see [page 10](#)), then press .
- 2 Press  to highlight Copy, then press OK.
- 3 Press  to highlight Network Computer , then press OK.

If this is the first time you are copying to your computer, you must first “allow” the frame to communicate with your computer.

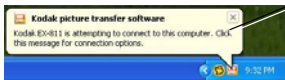

- 4 A Kodak picture transfer software message opens on your computer screen. Click the message to open the Allow screen.





- 5 Click Allow.
- 6 Return to the frame and recopy the picture.

If you did not see the message (from step 4 above) and you cannot copy files, see [Allow the frame on your computer, page 30](#).

NOTE: If you have more than one frame on your wireless network, give them unique names so you can tell them apart. Go to Home → Settings → Device configuration menu. See [page 20](#).

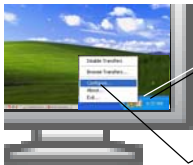
Changing copy settings in picture transfer software



- 1 Right-click the Kodak picture transfer software icon  in the lower right corner of your computer screen.
- 2 Select Configure to open the Kodak picture transfer software window.

Use this window to:

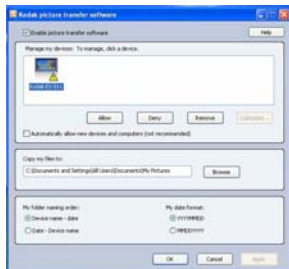

- Enable/Disable picture transfer software. Select/deselect the check box.
- “Allow” the frame on your computer. See below.
- Manage your device. Click the Deny, Remove, or Customize buttons.
- Designate a location to which your files are copied. Accept the default folder (C:\Documents and Settings\All Users\Documents\My Pictures) or click Browse and navigate to a different folder.
- Select a naming convention and date format for your destination folders.

Allow the frame on your computer

You must “allow” the frame to communicate with your computer before you can copy pictures from the frame to the computer.

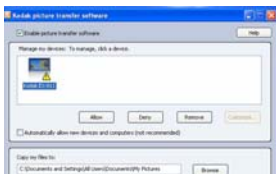

- 1 Right-click the picture transfer icon and select Configure (see above, [page 30](#)).
- 2 Click your frame in the *Manage my devices* window.
- 3 Click Allow.
- 4 Click Apply, then click OK.

Glossary of common wireless network terms

Access point—(Also called AP.) A wireless network transceiver or “base station” hub, often used to connect a local area network to one or more wireless devices. An access point can also provide a communication link to a wired local area network.

Ad Hoc—A client setting for a wireless local area network that allows devices connected to the network to communicate with one another directly, independent of an access point or router.

Bridge—A product that connects a local area network to another local area network that uses the same protocol (for example, wireless, Ethernet or token ring). Wireless bridges are commonly used to link buildings in campuses.

Client—An application on a computer or device connected to a network that requests services (files, print capability) from another connected computer or device on the network.

Device-to-device—See Ad Hoc.

DHCP—Dynamic Host Configuration Protocol: a utility that enables a server to dynamically assign IP addresses from a predefined list and limit their time of use so they can be reassigned. Without DHCP, all of the IP addresses of all the clients on the network would have to be manually entered. With DHCP, whenever a client connects to the network, it automatically gets an IP address assigned to it.

DNS—Domain Name System (or Service, or Server): a program that translates domain names to IP addresses by accessing a database maintained on a collection of Internet servers. The program works behind the scenes to facilitate surfing the Web with alpha versus numeric addresses. A DNS server converts a name like mywebsite.com to a series of numbers like 107.22.55.26. Every Web site has its own specific IP address on the Internet.

Domain name— The portion of a URL or Web address that identifies a specific Web site. For example, the domain name portion of the URL *http://www.kodak.com* is *kodak.com*.

All domain names have a suffix that indicates the top level domain (TLD) it belongs to. Examples include:

- com: US commercial business
- gov: US government agency
- edu: US educational institution
- mil: US military organization
- net: US network organization
- org: US nonprofit organization
- au: Australia
- br: Brazil
- ca: Canada
- de: Germany
- do: Dominican Republic
- es: Spain
- fr: France
- it: Italy
- nl: Netherlands
- pr: Puerto Rico
- pt: Portugal
- ru: Russian Federation
- uk: United Kingdom

DSL—Digital Subscriber Lines: various technology protocols for high-speed data, voice and video transmission over ordinary twisted-pair copper POTS (Plain Old Telephone Service) telephone wires.

Dynamic IP address—An IP address assigned to a client, each time the client connects to the network. The dynamic IP address is configured by the DHCP server and can be different each time the client connects to the network.

Encryption key—An alphanumeric (letters and/or numbers) series that enables data to be encrypted then decrypted so it can be safely shared among members of a network. WEP uses an encryption key that automatically encrypts outgoing wireless data. On the receiving side, the same encryption key enables the computer to automatically decrypt the information so it can be read.

Infrastructure—A client setting for a local area network that allows devices connected to the network to communicate with one another through a central access point or router. This configuration is commonly used in wireless home networks.

IP—Internet Protocol: technology that supports voice, data and video transmission via IP-based local area networks, wide area networks, and the Internet. This includes VoIP (Voice over IP).

IP address—A number that identifies each sender or receiver of information that is sent across the Internet.

Network name—Identifies the wireless network for all the shared components. During the installation process for most wireless networks, you must enter the network name or SSID. Different network names are used when setting up your individual computer, wired local area network, or workgroup.

Passphrase—A text string used for WPA security on a Wi-Fi wireless network. A passphrase may contain up to 31 alphanumeric characters, including spaces and other special characters.

NOTE: A passphrase used for WPA security is not the same as a WEP key, nor is it the same as a passphrase commonly found in router software that is used to generate a WEP key.

Router—An access point (AP) or hub that sends data from one local area network (LAN) or wide area network (WAN) to another. A router monitors and controls data flow and sends information using the most efficient route based on traffic load, line costs, speed, bad connections, etc.

SSID—Service Set Identifier: also referred to as a network name, since it is essentially a name that identifies a wireless network. The identifier is attached to the wireless local area network (WLAN) and acts as an identifier when a device tries to connect to the system. A device will not be permitted to join the network unless it can provide

the unique SSID. An SSID can be broadcast by the network router, allowing devices to detect it as an available network. An SSID does not supply security to the network.

SSL—Secure Sockets Layer: a commonly used encryption scheme used by many online retail and banking sites to protect the financial integrity of transactions.

TCP/IP—Transmission Control Protocol/Internet Protocol: the underlying technology behind the Internet and communications between computers in a network.

URL—Uniform Resource Locator: also referred to as a Web address, since it identifies the location of a file or resource on the Web. For example, the URL for the Eastman Kodak Company Web site is <http://www.kodak.com>.

WEP—Wired Equivalent Privacy: basic wireless security provided by Wi-Fi. In some instances, WEP may be all a home or small-business user needs to protect wireless data. WEP is available in 40-bit (also called 64-bit), or in 108-bit (also called 128-bit) encryption modes. As 108-bit encryption provides a longer algorithm that takes longer to decode, it can provide better security than basic 40-bit (64-bit) encryption.

WEP key—A text string used for WEP security on a Wi-Fi wireless network. A WEP key with 10 or 23 characters can include numbers and the letters A - F and are not case-sensitive. 5 and 13 character WEP keys can include numbers and all letters (as well as some special characters) and are case sensitive.

WPA—Wi-Fi Protected Access: a Wi-Fi security standard that provides a high level of wireless network security. It uses data encryption through the Temporal Key Integrity Protocol (TKIP). TKIP scrambles the keys and ensures that the keys haven't been tampered with. User authentication is performed through the Extensible Authentication Protocol (EAP) to ensure that only authorized network users can access the network.

Wi-Fi—Wireless Fidelity: a term developed by the Wi-Fi Alliance commonly used to describe any type of 802.11 standard wireless network. Products tested and approved as "Wi-Fi Certified" (a registered trademark) by the Wi-Fi Alliance are certified as interoperable with each other, even if they are from different manufacturers.

For more information, visit www.kodak.com/go/wifisupport or www.wi-fi.org.

6

Troubleshooting and support

For step-by-step product support, visit www.kodak.com/go/digitalframesupport and select Interactive Troubleshooting & Repairs.

Picture frame problems

If...	Try one or more of the following
Frame does not turn on.	<ul style="list-style-type: none"> ■ Make sure the power cable is securely connected (page 4). ■ Make sure you are using the power cable that was included with your frame. ■ Make sure the power switch on the frame is On (page 6).
Remote control does not function.	<ul style="list-style-type: none"> ■ Check the battery in the remote. ■ Make sure the power switch on the frame is On (page 6).
Frame does not recognize memory card.	<ul style="list-style-type: none"> ■ Purchase a certified SD/MMC card. ■ Insert a card into the slot, then push to seat (page 5).
Frame freezes up.	<ul style="list-style-type: none"> ■ Use a paper clip or other slim object to press the recessed reset button on the back of the frame (page ii).

Picture frame/computer communications

If...	Try one or more of the following
Cannot copy pictures to my computer.	<ul style="list-style-type: none"> ■ Make sure your computer is on. ■ Make sure the USB cable is securely connected (page 15).
Cannot see my frame as a removable drive.	<ul style="list-style-type: none"> ■ Make sure the power switch on the frame is On (page 6).

If...	Try one or more of the following
Cannot copy pictures from Kodak EasyShare software.	<ul style="list-style-type: none"> ■ Make sure your frame and computer are on. ■ Make sure the USB cable is securely connected (page 15). ■ Make sure you have installed the latest version of EasyShare software (page 1). ■ From My Collection in EasyShare software, make sure the pictures are in the Picture Tray.

Wireless network connection

For software installation and wireless frame setup, see the *Wireless Setup Guide*.

Problem	Possible causes and/or solutions
Frame cannot connect to the wireless network — “Wireless network not found” appears.	<ul style="list-style-type: none"> ■ Make sure you have a wireless router and that it is broadcasting the SSID, or enter the SSID manually. ■ Make sure your frame and computer are on. ■ Make sure you have installed Windows Media player 11 and you have allowed sharing in Media player. ■ Make sure the wireless router and network are running before the frame begins scanning for a network. ■ Make sure you are within the operating range of the network. Move the frame into the same room with the router. ■ Check for sources of interference in the wireless signal, such as a microwave oven or a cordless telephone. ■ Check with your router manufacturer for a possible firmware update. ■ Make sure your frame is using the latest firmware. Check www.kodak.com/go/digitalframesupport for updates.

Problem	Possible causes and/or solutions
<p><i>(Continued from previous table)</i></p> <p>Frame cannot connect to the wireless network — “Wireless network not found” appears.</p>	<ul style="list-style-type: none"> ■ Make sure the network profile settings on your frame match those of the network. In an Infrastructure network, you can usually view the network settings with the software program included with the router or through the interface of a connected device. See the router or device documentation for details. <p>If possible, note the following settings for the network, then change the profile settings on your frame to match them:</p> <ul style="list-style-type: none"> – SSID – Wi-Fi mode (Infrastructure) – Security (none, WEP, or WPA-PSK) – Dynamic IP (yes or no) – Connect Mode (yes - ask before connecting, or no - connect automatically) – Router set up for MAC address access? Add frame MAC address to router access list. <p>NOTE: Many wireless network routers employ the use of a WEP passphrase for generating a WEP security key code. If WEP security is enabled for the network, make sure the key code, not the passphrase, is entered in the security settings for the network profile on the camera.</p>

Problem	Possible causes and/or solutions
(Continued)	<p>The wireless router did not assign a valid network IP address to the frame. Check and change the router settings, as indicated below. You can usually view the network settings with the software program included with the router.</p> <ul style="list-style-type: none"> ■ Enable DHCP on the router. ■ Change the setting on the router to allow both 802.11b and 802.11g Wi-Fi protocols. ■ Change router settings to allow enough IP addresses for the number of wireless devices on the network. ■ Disable MAC filtering on the router or enable the MAC for the frame. ■ Temporarily disable the QoS (Quality of Service) setting on the router. ■ Check with the router manufacturer for a possible firmware update. <p>See the router documentation for details.</p>
Frame cannot connect to Kodak Gallery.	<ul style="list-style-type: none"> ■ The Gallery address, account email address, or account password on the frame are incorrect. ■ Make sure the wireless router is connected to the Internet and an Internet connection is available. ■ The Gallery or online picture service is temporarily unavailable. Try again later. ■ There may not be a Kodak Gallery service in the region you are in. <p>See <i>Frame cannot connect to the wireless network</i>, above, for other possible causes and/or solutions.</p>
Cannot copy from frame to computer via wireless network. "Please allow the frame on the computer" appears.	<p>Your frame has not been given permission to communicate with your computer.</p> <ul style="list-style-type: none"> ■ Open Kodak picture transfer software and allow your frame to have access to your computer. See page 29.

Screen messages

Screen message	Try one or more of the following
Create file failed.	<p>The device (memory card, USB drive, camera, etc.) you are trying to copy to is protected.</p> <ul style="list-style-type: none"> ■ See your device documentation to remove write protection. ■ Insert or connect a different device.
Error attempting to open file or directory.	<ul style="list-style-type: none"> ■ Turn off the frame, then turn it back on. If the problem persists, contact customer support help, at www.kodak.com/go/digitalframesupport.
Error duplicate file name.	
Error occurred while closing a file.	
Error invalid file name	
Error reading from file.	
Error writing from file.	
Error writing a file.	
Error writing to a file.	
File Copy Failed!	
Internal error.	
Parameter is invalid.	
Unknown error.	
Please enter your SSID.	<ul style="list-style-type: none"> ■ Enter the name of your network. If you do not know it, contact your system administrator or the person who set up your wireless network.
Printer unavailable. Unable to connect to printer.	<ul style="list-style-type: none"> ■ Make sure your printer is on and the USB cable is securely connected (page 13). ■ Make sure you changed your USB connection mode from computer to printer (page 13).

Screen message	Try one or more of the following
Printing error.	<ul style="list-style-type: none"> ■ Make sure your printer is on and the USB cable is securely connected (page 13). ■ Check your printer for more info.
Time out occurred while printing.	<ul style="list-style-type: none"> ■ Check cables and printer supplies. Print again.
Unable to create file. Device write protected or full.	<p>The frame was unable to copy the picture.</p> <ul style="list-style-type: none"> ■ Insert a different card or device (page 5), or change the picture location setting (page 8). ■ Remove write protection, unlock card. ■ Delete pictures from card.
Disk full.	
Unable to get dynamically assigned IP address.	<p>DHCP (see Glossary) is not enabled at the router.</p> <ul style="list-style-type: none"> ■ Make sure your router is properly configured and DHCP is enabled. ■ Contact your system administrator or the person who set up your wireless network.
Verify network settings.	<ul style="list-style-type: none"> ■ Contact your system administrator or the person who set up your wireless network.
Verify security code.	<p>You have network security turned on.</p> <ul style="list-style-type: none"> ■ Enter the security code you created when you set up your wireless network. ■ Contact your system administrator or the person who set up your wireless network.
Write failed. Select another location.	<p>The frame was unable to copy the picture.</p> <ul style="list-style-type: none"> ■ Insert a different card or device (page 5), or change the picture location setting (page 8).

7

Appendix

Digital frame specifications

For more specifications, visit www.kodak.com/go/digitalframesupport.

Kodak EasyShare wireless digital picture frame	
Wi-Fi wireless network compatibility	
Wi-Fi 802.11b protocol—compatible with Wi-Fi wireless 802.11b and 802.11g networks.	
Color display	
EX811	20.3 cm (8 in.) diagonal digital LCD, 800 x 480 pixels, 4:3 or 16:9 aspect ratio, 17.6 x 10 cm (6.9 x 3.9 in.) viewable area
EX1011	25.4 cm (10 in.) diagonal digital LCD, 800 x 480 pixels, 16:9 aspect ratio, 23.5 x 14.6 cm (9.3 x 5.8 in.) viewable area
Battery, remote control	
CR2025, 3V lithium cell, included	
Internal storage capacity	
128 MB	
Power	
100-120V AC 60Hz (US), 100-240V 50-60Hz (WW), 12V DC adapter	
Communication with computer	
USB 2.0 (PIMA 15740 protocol), via USB cable model U-8	
Other features	
PictBridge support	Yes
Picture formats	JPEG, EXIF 2.2

Kodak EasyShare wireless digital picture frame	
Video formats	MOV, AVI, MPG, MPEG (Video formats created with digital cameras are certified for Kodak digital picture frames. Videos created with or copied from other sources may not play on the frame.)
Music format	MP3
Memory cards	CompactFlash, MicroDrive, Secure Digital, Memory Stick, xD, MultiMedia Card
Tripod mount	1/4 inch
Temperature	Operating: -4 to 140°F (-20 to 60°C) Storage: -22 to 185°F (-30 to 85°C)
Size	EX811: 28.5 cm (11.2 in.) x 21 cm (8.3 in.) x 3.8 cm (1.5 in.) EX1011: 33 cm (13 in.) x 24 cm (9.5 in.) x 3.8 cm (1.5 in.)

Important safety instructions



CAUTION:

Do not disassemble this product; there are no user-serviceable parts inside. Refer servicing to qualified service personnel. Do not expose this product to liquid, moisture, or extreme temperatures. The use of controls, adjustments, or procedures other than those specified herein may result in exposure to shock and/or electrical or mechanical hazards. If the LCD breaks, do not touch the glass or liquid. Contact Kodak customer support.

- The use of an accessory that is not recommended by Kodak may cause fire, electric shock, or injury. For approved accessories, visit www.kodak/go/accessories.
- Use only a USB-certified computer equipped with a current-limiting motherboard. Contact your computer manufacturer if you have questions.
- When removing the battery from the remote, allow it to cool; it may be hot.
- Follow all warnings and instructions supplied by the battery manufacturer.
- Use only batteries approved for this product to avoid risk of explosion.
- Keep batteries out of the reach of children.
- Do not allow batteries to touch metal objects, including coins. Otherwise, a battery may short circuit, discharge energy, become hot, or leak.
- Do not disassemble, install backward, or expose batteries to liquid, moisture, fire, or extreme temperature.
- Remove the battery when the product is stored for an extended period of time. In the unlikely event that battery fluid leaks inside the product, contact Kodak customer support.
- In the unlikely event that battery fluid leaks onto your skin, wash immediately with water and contact your local health provider. For additional health-related information, contact your local Kodak customer support.
- Dispose of batteries according to local and national regulations. Visit

www.kodak.com/go/kes.

- Do not charge non-rechargeable batteries.
For more information on batteries, visit www.kodak.com/go/batterytypes.
- Digital picture frame and remote control battery may include perchlorate material. Special handling may apply in California.
- Read and follow all warnings and instructions supplied by the battery manufacturer.



CAUTION:

EX models only: When using this product, it should be installed and operated with a minimum distance of 7.9 in. (20 cm) for 2.4 GHz operations between the radiator and your body. This transmitter must not be collocated or operate in conjunction with any other antenna or transmitter.

Upgrading your software and firmware

Upgrade to the latest versions of the software included on the Kodak EasyShare software CD and the frame firmware—www.kodak.com/go/digitalframedownloads. See [page 22](#) for upgrading firmware.

Additional care and maintenance

- Wipe the frame and the LCD gently with a soft, lint-free cloth or an untreated lens-cleaning tissue. Do not use cleaning solutions unless designed specifically for LCD screens. Do not allow chemicals, such as suntan lotion, to contact painted surfaces.
- Service agreements are available in some countries. Contact a dealer of Kodak products for more information.
- For digital frame disposal or recycling information, contact your local authorities. In the US, visit the Electronics Industry Alliance Web site at www.eiae.org or visit www.kodak.com/go/digitalframesupport.

Limited warranty

Kodak warrants Kodak consumer electronic products and accessories ("Products"), excluding batteries, to be free from malfunctions and defects in both materials and workmanship for one year from the date of purchase. Retain the original dated sales receipt. Proof of the date of purchase will be required with any request for warranty repair.

Limited warranty coverage

Warranty service is only available from within the country where the Products were originally purchased. You may be required to ship Products, at your expense, to the authorized service facility for the country where the Products were purchased. Kodak will repair or replace Products if they fail to function properly during the warranty period, subject to any conditions and/or limitations stated herein. Warranty service will include all labor as well as any necessary adjustments and/or replacement parts. If Kodak is unable to repair or replace a Product, Kodak will, at its option, refund the purchase price paid for the Product provided the Product has been returned to Kodak along with proof of the purchase price paid. Repair, replacement, or refund of the purchase price are the sole remedies under the warranty. If replacement parts are used in making repairs, those parts may be remanufactured, or may contain remanufactured materials. If it is necessary to replace the entire Product, it may be replaced with a remanufactured Product. Remanufactured Products, parts and materials are warranted for the remaining warranty term of the original Product, or 90 days after the date of repair or replacement, whichever is longer.

Limitations

This warranty does not cover circumstances beyond Kodak's control. This warranty does not apply when failure is due to shipping damage, accident, alteration, modification, unauthorized service, misuse, abuse, use with incompatible accessories or attachments (such as third party ink or ink tanks), failure to follow Kodak 's operation, maintenance or repacking instructions, failure to use items supplied by Kodak (such as adapters and cables), or claims made after the duration of this warranty. Kodak makes no other express or implied warranty for this product, and

disclaims the implied warranties of merchantability and fitness for a particular purpose. In the event that the exclusion of any implied warranty is ineffective under the law, the duration of the implied warranty will be one year from the purchase date or such longer period as required by law. The option of repair, replacement, or refund is Kodak's only obligation. Kodak will not be responsible for any special, consequential or incidental damages resulting from the sale, purchase, or use of this product regardless of the cause. Liability for any special, consequential or incidental damages (including but not limited to loss of revenue or profit, downtime costs, loss of the use of the equipment, cost of substitute equipment, facilities or services, or claims of your customers for such damages resulting from the purchase use or failure of the Product), regardless of cause or for breach of any written or implied warranty is expressly disclaimed.

Your rights

Some states or jurisdictions do not allow exclusion or limitation of incidental or consequential damages, so the above limitation or exclusion may not apply to you. Some states or jurisdictions do not allow limitations on how long an implied warranty lasts, so the above limitation may not apply to you. This warranty gives you specific rights, and you may have other rights which vary from state to state or by jurisdiction.

Outside the United States and Canada

In countries other than the United States and Canada, the terms and conditions of this warranty may be different. Unless a specific Kodak warranty is communicated to the purchaser in writing by a Kodak company, no warranty or liability exists beyond any minimum requirements imposed by law, even though defect, damage, or loss may be by negligence or other act.

FCC compliance and advisory



Kodak EasyShare wireless digital picture frame

This equipment has been tested and found to comply with the limits for a Class B digital device, pursuant to Part 15 of the FCC Rules. These limits are designed to provide reasonable protection against harmful interference in a residential installation.

This equipment generates, uses, and can radiate radio frequency energy and, if not installed or used in accordance with the instructions, may cause harmful interference to radio communications. However, there is no guarantee that interference will not occur in a particular installation.

If this equipment does cause harmful interference to radio or television reception, which can be determined by turning the equipment off and on, the user is encouraged to try to correct the interference by one or more of the following measures: 1) reorient or relocate the receiving antenna; 2) increase the separation between the equipment and the receiver; 3) connect the equipment to an outlet on a circuit different from that to which the receiver is connected; 4) consult the dealer or an experienced radio/TV technician for additional suggestions.

Any changes or modifications not expressly approved by the party responsible for compliance could void the user's authority to operate the equipment. Where shielded interface cables have been provided with the product or specified additional components or accessories elsewhere defined to be used with the installation of the product, they must be used in order to ensure compliance with FCC regulation.

FCC and Industry Canada

This device complies with Industry Canada RSS-210 and FCC Rules. Operation is subject to the following two conditions: (1) this device may not cause harmful interference, and (2) this device must accept any interference received, including interference that may cause undesired operation.

FCC et Industrie Canada

Cet appareil est conforme à la norme RSS-210 d'Industrie Canada et aux réglementations de la FCC. Son utilisation est soumise aux deux conditions suivantes : (1) cet appareil ne doit pas provoquer d'interférences nuisibles, et (2) cet appareil doit supporter les interférences reçues, y compris celles susceptibles de nuire à son bon fonctionnement.

CE

Hereby, Eastman Kodak Company declares that this Kodak product is in compliance with the essential requirements and other relevant provisions of Directive 1999/5/EC.

This digital picture frame EX-811 and EX-1011 transmits in 12dBm. In France, the power level is limited to 10dBm in outdoor environments, per regulations. When in France, use the wireless functions of this device indoors only.

Canadian DOC statement

DOC Class B Compliance—This Class B digital apparatus complies with Canadian ICES-003.

Observation des normes-Classe B—Cet appareil numérique de la classe B est conforme à la norme NMB-003 du Canada.

Waste Electrical and Electronic Equipment labeling



EU: It is the final user's responsibility to discard this equipment into an approved, segregated collection scheme to enable its suitable treatment/disposal and to improve human/environmental protection. For more information, see your retailer, local authority, or www.kodak.com/go/recycle. Product weight: EX811 - 794 g.; EX1011 - 830 g.

The lamps inside the EX-1011 model contain mercury and must be recycled or disposed of in accordance with local, state, or federal laws. For more information on recycling, visit www.lamprecycle.org or www.eiae.org. Find additional information at www.kodak.com/go/hse or 1-800-242-2424.

Australian C-Tick



MPEG-4

Use of this product in any manner that complies with the MPEG-4 visual standard is prohibited, except for use by a consumer engaging in personal and non-commercial activities.

Russian GOST-R



Eastman Kodak Company
Rochester, New York 14650

Фотокамера изготовлена в Китае; остальные элементы -
в соответствии с маркировкой.

Korean Class B ITE

이 기기는 가정용으로 전자파적합등록을 한 기기로서 주거지역에서는 물론 모든 지역에서 사용할 수 있습니다.

Licensing

Supply of this product does not convey a license nor imply any right to distribute content created with this product in revenue-generating broadcast systems (terrestrial, satellite, cable and/or other distribution channels), streaming applications (via Internet, intranets and/or other networks), other content distribution systems (pay-audio or audio-on-demand applications and the like) or on physical media (compact discs, digital versatile discs, semiconductor chips, hard drives, memory cards and the like). An independent license for such use is required. For details, please visit <http://mp3licensing.com>.

China RoHS

环保使用期限 (EPUP)

在中国大陆，该值表示产品中存在的任何危险物质不得释放，以免危及人身健康、财产或环境的时间期限（以年计）。该值根据操作说明中所规定的产品正常使用而定。

Environmental Protection Use Period (EPUP)

In China, this number indicates the time period (in years) within which any hazardous substances present in the product are not expected to be released such that there is risk to human health, property, or the environment. This value is assigned based on normal use of the product as described in the operating instructions.

Product Disclosure Table

有毒有害物质或元素名称及含量标识表
table of hazardous substances' name and concentration

部件名称 Component name	有毒有害物质或元素 hazardous substances' name					
	铅 (Pb)	汞 (Hg)	镉 (Cd)	六价铬 (Cr6+)	多溴联苯 (PBB)	多溴二苯 醚 (PBDE)
数码相架电路板元件 (Digital Photo Frame circuit board components)	X	O	O	O	O	O
控制器 (Controller)	X	O	O	O	O	O
交流变压器电路板元件 (AC Adapter circuit board components)	X	O	O	O	O	O
<p>O: 表示该有毒有害物质在该部件所有均质材料中的含量均在SJ/T 11363-2006规定的限量要求以下。 X: 表示该有毒有害物质至少在该部件的某一均质材料中的含量超出SJ/T 11363-2006规定的限量要求。 O: indicates hazardous substance concentration lower than MCV X: indicates hazardous substance concentration higher than MCV</p>						



USB 数据线

Index

A

- about, frame, 20
- allow the frame, 30
- appendix, 41
- arrow buttons on remote, 3
- automatic on/off, 19, 21

B

- back button on remote, 3
- battery
 - remote control, 41
 - replacing, 2
 - safety, 43
- brightness, screen, 19
- buttons
 - on back of frame, ii
 - on remote control, 3

C

- cables
 - power, connecting, 4
 - USB, connecting, 5
- camera, connecting, 5
- card. see memory card
- changing picture locations, 8
- check mark, select button, 3
- clock and timer, setting, 19, 20, 21
- computer
 - connecting to frame, 15
 - copying to/from, 15
 - help with communicating, 35
- connection mode, 14, 20

- connectors on frame, ii
- copying
 - from EasyShare software, 16
 - on frame, 14
 - to/from computer, USB, 15
 - wireless, 29

D

- DC-in, ii
- deleting pictures and videos, 16
- device configuration, 20
- displaying slide show, 9
- disposal, recycling, 44
- doing more with your frame, 12
- downloading firmware, software, 22

E

- EasyShare software
 - copying pictures from, 16
 - installing, 1
- error messages, 39

F

- faceplate, i
- fast forward video, 3, 10
- firmware
 - checking version, 20
 - upgrading, 18, 22, 44
- flash drive, connecting, 5
- frame, picture
 - assign a name, 20
 - changing orientation, 7

- checking model, firmware, 20
- product views, i
- setup, 4
- setup wireless network, 20
- specifications, 41
- troubleshooting, 35
- turning on/off, 6

G

- glossary, wireless terms, 31

H

- headphone jack, ii
- help
 - communicating with computer, 35
 - connecting to gallery, 38
 - frame, 35
 - troubleshooting problems, 35
- holder, remote control, i
- home
 - button on remote, 3
 - changing picture locations, 8
 - screen, 8

I

- installing software, 1
- internal memory
 - capacity, 41
 - My Frame, 8
- internet
 - requirements for wireless, 24
 - set clock from, 21

K

- KODAK Gallery
 - problem connecting, 38
 - set up account, 20
 - viewing My Friends' Albums, 27
 - viewing your albums, 26

L

- landscape, set orientation, 19
- language
 - setting, 20
 - setting first time, 6
- LCD. see screen
- loading software, 1

M

- magnify picture, 3
- memory card
 - inserting, 5
 - slots, i
 - types, 5
- menu button on remote, 3
- multi-up view, 9
- music
 - adjust volume, 3
 - button on remote, 3
 - mute, 3
 - playing, 12
- My Frame, internal memory, 8
- My Friends' Albums, viewing, 27

N

- name, frame, 20
- network, wireless setup, 20

O

- OK button on remote, 3
- on/off switch, i
- on/off, setting auto, 19, 21
- orientation setting, 7, 19

P

- PictBridge enabled printer, 13
- picture transfer software
 - allow the frame, 30
 - copy settings, 30
 - copying wirelessly, 29
- pictures
 - copying connected, 15
 - copying from EasyShare software, 16
 - copying on frame, 14
 - copying wireless, 29
 - deleting, 16
 - location, changing, 8
 - printing, 13
 - selecting more than one, 17
 - viewing, 8
- play/pause, video, 10
 - button on remote, 3
- playing
 - music, 12
 - video, 10
- portrait, set orientation, 19
- power
 - button on remote, 3
 - connecting, 4
 - connector, ii
 - specifications, 41
 - turning on, 6

- printer connection mode, 14, 20
- printing, PictBridge printer, 13

R

- recycling, disposal, 44
- regulatory compliance, 47
- remote control
 - activating, 1
 - battery type, 41
 - holder, i
 - replacing battery, 2
 - sensor on frame, i
 - storing, 1
 - using, 3
- reset button, recessed, ii
- rewind video, 10
 - button on remote, 3
- rotate picture, 3
- running slide show, 9

S

- safety information, 43
- screen, i
 - cleaning, 44
 - error messages, 39
 - setting brightness, 19
- select button on remote, 3
- selecting multiple pictures, 17
- sensor, remote control, i
- setting
 - auto on/off, 19, 21
 - language, 20
 - language first time, 6
 - screen brightness, 19

- time, 19
 - viewing options, 19
 - wireless operation, 24
- settings, changing, 18
- setup
 - picture frame, 4
 - wireless network, 20, 24
- slide duration, setting, 19
- slide show
 - button on remote, 3
 - running, 9
 - viewing first, 7
- slide transitions, setting, 19
- software
 - installing, 1
 - upgrading, 44
- source, picture location, 8
- speakers, i
- specifications, frame, 41
- stand, frame, i
- stop
 - button on remote, 3
 - video, 10
- storage capacity, internal memory, 41
- switch, on/off, i

T

- thumb drive. See flash drive., 5
- thumbnails, 9
- time, setting, 19
- transitions, slides, setting, 19
- troubleshooting
 - error messages, 39
 - frame, 35
 - wireless network connection, 36

- turning on/off frame, 6

U

- upgrading
 - firmware, 18, 22
 - software and firmware, 44
- USB connection mode, 14, 20
- USB connector, ii
- USB device, connecting, 5

V

- video, playing, 10
- viewing
 - first slide show, 7
 - from KODAK Gallery, 26
 - full screen picture, 10
 - My Friends' Albums, 27
 - pictures, wireless network, 25
 - pictures/videos, 8
 - thumbnails, 9
- volume, adjust, ii, 3, 10

W

- wall mount hangers, i
- warranty, 45
- wireless
 - copying, 29
 - features on frame, overview, 24
 - glossary of terms, 31
 - network, troubleshooting, 36
 - setup, 20, 24
 - viewing pictures, 25

Z

- zoom picture, 3