Kodak ESP 3

All-in-One Printer



User's Guide



Eastman Kodak Company
Rochester, New York 14650
© Eastman Kodak Company, May 2008

Kodak and EasyShare are trademarks of Eastman Kodak Company.

The Bluetooth® word mark and logos are owned by the Bluetooth SIG, Inc., and any use of such marks is under license.

©1989-2007 I.R.I.S. (Image Recognition Integrated Systems), All Rights Reserved

P/N IK3254 Revision E

January 2009

Product Overview	1
Memory Card Slots	1
Memory Cards Supported.....	1
Control Panel Layout	2
Main Components.....	4
USB Port	5
Status Lights.....	5
AiO Home Center (Windows).....	8
AiO Home Center (Macintosh).....	9
Getting Started	11
Printer Location.....	11
Printing a Demo Page	11
Status Monitor (Windows Only)	11
Setting Options for the Status Monitor.....	11
Handling and Loading Paper	13
Loading an Original	13
Handling Paper	15
Loading the Paper Tray	15
Loading 4 x 6 Photo Paper	16
Loading Envelopes.....	17
Print.....	19
Transfer Pictures to Computer	19
Transfer to a Windows computer	19
Transfer to a Macintosh computer	20
Print Pictures from a PictBridge Camera.....	20
Print from a Bluetooth Device	20
Range.....	21
Bluetooth Name.....	21
Panoramic Photos.....	21
Print Layouts	22
4x6 Inch Paper	23
5x7 Inch Paper	24
8x10 Inch Paper	25
US Letter.....	26
A4 Paper.....	28
4 X 12 Paper.....	30

Copy	31
Scan	33
Scan from Control Panel (Windows)	33
Scan from Control Panel (Macintosh)	33
Maintenance	35
General Care	35
Cleaning the Scanner Glass	36
Cleaning the Scanner Lid	36
Printing a Test Page	36
Ink Cartridges	37
Checking Ink Levels	37
Replacing Ink Cartridges	37
Printhead	38
Printhead Alignment	39
Clean Printhead	39
Replace the Printhead	40
Support	43
Contact Kodak	43
Troubleshooting	44
Printer Fails to Power On	44
Device not Recognized	44
Ink Cartridge Not Recognized	45
Multiple Paper Feed	45
Multiple Pictures Not Scanned Properly	45
No Communication with Computer	46
No Paper Feed	47
Paper Jam	47
Printer not Responding	47
Transfer Pictures Failure	48
Wrong Paper Size	48
Print Troubleshooting	48
Envelope Printing Incorrect	48
Multiple-page Document in Reverse Order	49
PictBridge Camera not Detected	49
Picture Cropped	49
Picture Print Smudged	50
Picture Will Not Print	50
Poor Print Quality	50
Print Skewed or Slanted	50
Print Spotted	51
Print Too Dark	51
Print Too Light	51
Printing Slow	51
Printing Stops	52
White Edges on Borderless Prints	52

Copy Troubleshooting.....	52
Copy Cut Off	52
Scan Troubleshooting.....	53
Scan Fails.....	53
Scanned Image Blank	53
Appendix	55
Kodak ESP 3 All-in-One Printer Specifications.....	55
System Requirements	57
Paper Supported	58
Safety	58
Parts.....	59
Power.....	59
Location	59
Environment	59
Regulatory Compliance.....	60
FCC Compliance and Advisory	60
FCC and Industry Canada.....	60
Canadian DOC Statement	60
German Compliance Statement.....	61
Waste Electrical and Electronic Equipment labeling.....	61
Glossary.....	63
Index.....	65

1 Product Overview

The Kodak ESP 3 All-in-One printer allows you to print, copy, and scan pictures or documents. Many functions can be operated directly from the control panel. In addition, you can print, store, manage, and share your digital pictures with family members and friends using Kodak Home Center software.

Memory Card Slots



You can insert a memory card directly into one of the memory card slots on the Kodak ESP 3 All-in-One printer. The printer supports connection of only one memory card device at a time.



The green LED memory card light located to the left of the memory card slots flashes while the card is being accessed.

Important To avoid damage to the memory card, do not remove the card while the LED is blinking.

Memory Cards Supported

The Kodak ESP-3 All-in-One printer supports the memory cards used in most digital cameras.

XD xD-Picture Card

MS Memory Stick, Memory Stick Pro

SD Secure Digital Card/Multi-MediaCard

CF Compact Flash type I and type II, including microdrives

SDHC Secure Digital High Capacity cards

The printer also supports the following memory cards with Memory Stick and SD/MMC card slot adapters you can purchase.

- Memory Stick Duo
- miniSD
- MicroSD (TransFlash)

Control Panel Layout

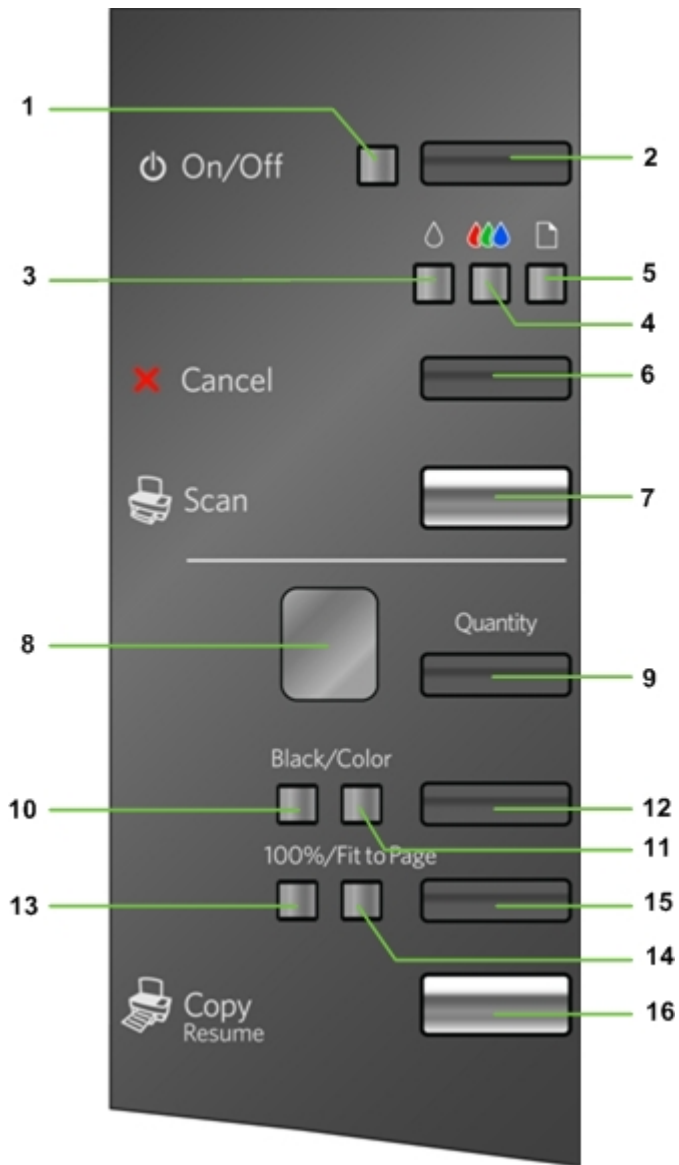

Number	Name	Description
1	On/Off light	Solid green when ready. Flashing green when printer is busy (starting up, copying, printing, scanning, or performing maintenance). Flashes red when there is an error. Solid amber when there is a failure that requires support from customer service. Not lit when power is off.
2	On/Off button	Turns the Kodak ESP 3 All-in-One printer on and off. If the printer is busy processing a job, pressing On/Off cancels the job and turns the printer off.
3	Check Black Ink light	Flashes very slowly when cartridge is low on ink. Flashes when cartridge needs replacing. Flashes fast when cartridge is missing or not inserted correctly.
4	Check Color Ink light	Flashes very slowly when cartridge is low on ink. Flashes when cartridge needs replacing. Flashes fast when cartridge is missing or not inserted correctly.
5	Check Paper light	Flashes when: Out of paper Paper jam Wrong paper size
6	Cancel button	Cancels a copy, print, or scan operation.
7	Scan button	Starts a scan job and sends the scanned image to the computer.
8	Quantity display	Displays how many copies will be produced (1 to 9).
9	Quantity button	Selects the number of copies to print (1 to 9).
10	Black light	Indicates copies will print in black and white and use only black ink (grayscale).
11	Color light	Indicates copies will print in color when the original is in color.
12	Copy Color button	Toggles between Black & White (grayscale) and Color copies. The default is Color.
13	100% light	Indicates the print size will match the size of the original.
14	Fit to Page light	Indicates the print size is Fit to Page.
15	Copy Print Size button	Toggles between print sizes of 100% and Fit to Page . The default is 100% . 100% produces a 1:1 copy, if the output paper is the same size or larger than the original. Fit to page fills the output page with the image, creating a borderless print.
16	Copy Resume	Starts a copy job using selected quantity, size, and color settings. Resumes a job when a recoverable error has occurred.

Main Components

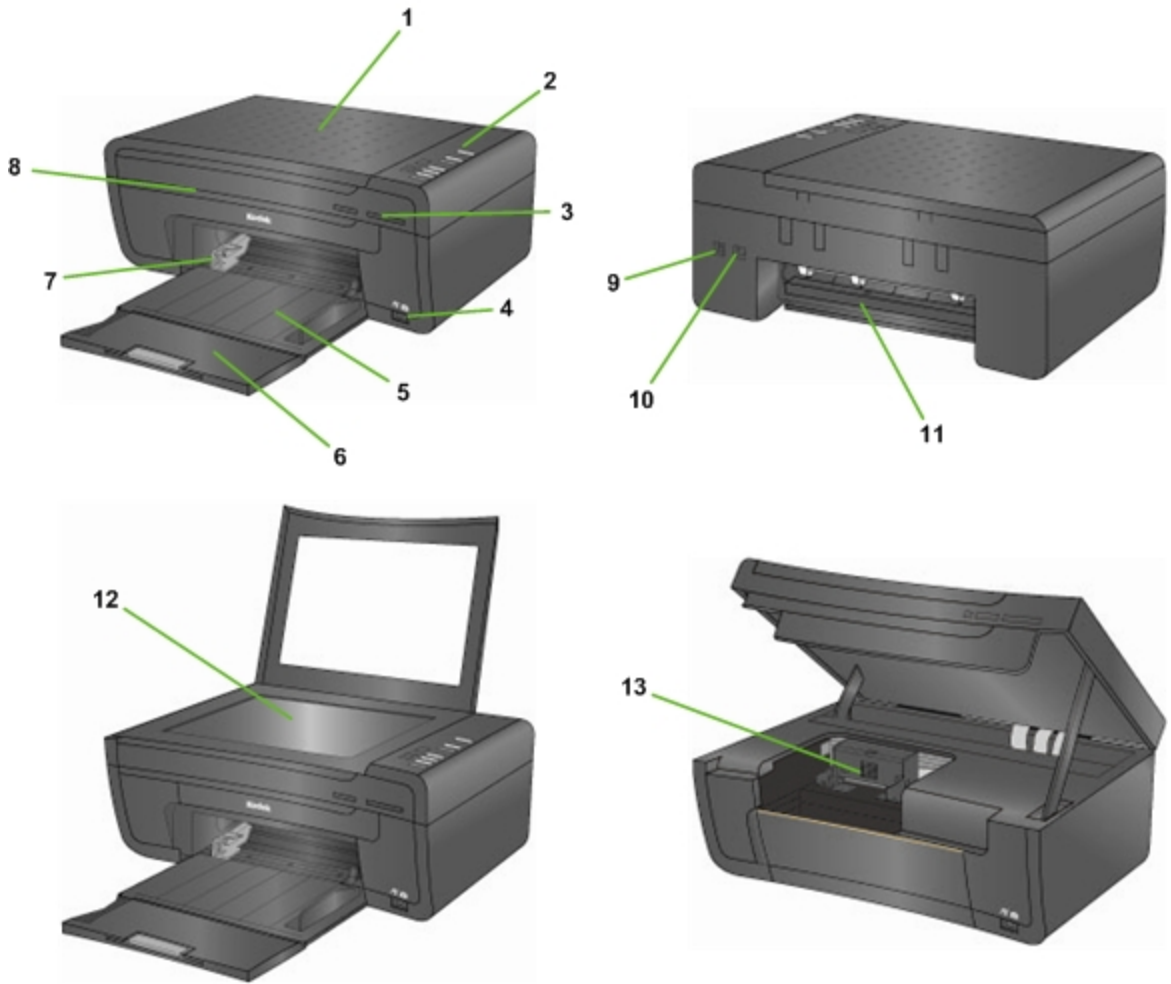

Number	Name
1	Scanner lid
2	Control panel
3	Memory card slots and memory card status light
4	USB host port (for connecting PictBridge cameras, PTP cameras, and USB mass storage devices)
5	Paper tray
6	Output tray extender
7	Paper width guide
8	Printer access door
9	USB device port (for connecting to the computer)
10	Power connector
11	Rear cleanout area
12	Scanner glass
13	Printhead

USB Port







You can use the USB port on the front panel of the Kodak ESP 3 All-in-One printer to connect a PictBridge camera and print pictures directly from the camera. The Kodak ESP 3 All-in-One printer can access images from most digital cameras.

You can also use the USB port to access pictures on a USB device, such as a thumb drive, and transfer them to your computer.





Status Lights



The following tables provide information on the Kodak ESP 3 All-in-One printer status lights.

Control Panel		
Light Status	Cause	Action/Solution
All lights and displays are off.	The printer is turned off.	Press On/Off to turn the printer on.
	The printer does not have power applied.	Ensure that the power cord is properly plugged into the back of the printer.
All lights flash once.	The printer is initializing.	None. Allow the printer to finish the initialization process.
All lights are flashing and the On/Off light is flashing amber.	The printer has detected an error condition.	Disconnect power for 5 seconds and reconnect power. If the condition persists, contact Kodak for assistance.

Check Color Ink Light		
Light Status	Cause	Action/Solution
Check Color Ink  light is off.	Normal operation. This light should be off when a color ink cartridge has been properly installed and has enough ink to print.	None.
Check Color Ink  light blinks every few seconds.	The color ink cartridge ink level is low.	Check the ink level in the Home Center or on the printer status monitor (Windows).
Check Color Ink  light is flashing.	The color ink cartridge needs to be replaced.	Replace the color ink cartridge.
Check Color Ink  light is flashing rapidly.	The color ink cartridge needs attention.	Ensure that the color ink cartridge is installed properly.

On/Off Light		
Light Status	Cause	Action/Solution
On/Off light is off.	The printer is turned off.	Press On/Off to turn the printer on.
	The printer does not have power applied.	Ensure that the power cord is properly plugged into the back of the printer.
	The printer needs attention.	Disconnect the power for 5 seconds and reconnect the power. If the problem persists, contact Kodak for assistance.
The On/Off light is steady green.	The printer is properly powered up, on, and ready.	None. You may start printing, copying, scanning, or other tasks.
The On/Off light is flashing green.	The printer is busy.	None. Normal operation when performing a print, copy, scan, or other job request.
	The printer is initializing.	None. Please wait and allow the printer to complete the initialization process (about 30 seconds). If the flashing green persists, you may have an issue with the printer. Visit www.kodak.com for additional troubleshooting steps or contact your local Kodak Call Center.
	The printer is calibrating.	None. Please wait and allow the printer to complete the calibration process (about 5 minutes).
	The printer is preparing to print, copy, or scan.	None
The On/Off light is steady amber.	The printer has detected an error condition.	Disconnect power for 5 seconds and reconnect power. If the condition persists, check the Quantity display for additional codes. Contact Kodak for assistance. Check the status monitor (Windows) on your computer for a message.
The On/Off light is flashing red.	The printer has detected an error condition that needs your attention.	Please check for other lights and follow the instruction for that light. Check the status monitor (Windows) on your computer for a message.

Check Black Ink Light		
Light Status	Cause	Action/Solution
Check Black Ink  light is off.	Normal operation. This light should be off when a black ink cartridge has been properly installed and has enough ink to print.	None.
Check Black Ink  light blinks every few seconds.	The black ink cartridge ink level is low.	Check the ink level in the Home Center or on the printer status monitor (Windows).
Check Black Ink  light is flashing.	The black ink cartridge needs to be replaced.	Replace the black ink cartridge.
Check Black Ink  light is flashing rapidly.	The black ink cartridge needs attention.	Insure that the black ink cartridge is installed properly.

Check Paper Light		
Light Status	Cause	Action/Solution
Check Paper  light is off.	Normal operation. This light should be off when paper is properly loaded in the paper tray.	None.
Check Paper  light is flashing red.	The paper tray is out of paper, there is a paper jam, or the wrong size paper is loaded.	Load the paper tray with paper, clear the paper jam, or load the correct size paper. Press Copy to continue.

Black and Color Lights		
Light Status	Cause	Action/Solution
Color light is on.	Indicates a document will be copied in color.	Press Copy Color button to choose color or black and white output.
Black light is on.	Indicates a document will be copied in black and white.	

100% and Fit to Page Lights		
Light Status	Cause	Action/Solution
100% light is on.	Indicates a copied document or photo will match the size of the original as long as the loaded paper is the same size or larger.	Press Copy Print Size button to choose 100% or Fit to Page .
Fit to Page light is on.	Indicates a copied document or photo will fill the output page with the image, cutting off what won't fit.	

Quantity Display		
Light Status	Cause	Action/Solution
1 - 9	Indicates the number of copies to be made.	Press Quantity to select the number of copies you want to make.
Flashing C	Indicates that printhead calibration must be started.	As needed, load the paper tray with plain paper (Letter-size or A4). Press the Copy button.
Flashing E	The printhead is not installed or not installed correctly.	Remove any ink cartridges that may be installed. Remove the printhead and then re-install the printhead. Re-install the ink cartridges and close the lid. A new calibration sheet will print.



AiO Home Center (Windows)

The AiO Home Center software is an application that runs on the computer. It enables you to print, copy, scan, and configure your All-in-One printer from the computer.

The six large icons on the AiO Home Center main window let you:

- Scan Pictures and Documents
- Copy Pictures
- Enhance and Print Pictures
- Configure Settings for Printing, Copying, and Scanning.
- Access My Resource Center at Kodak
- Order Supplies

There are three small icons in the upper right corner of the window:

-  Returns you to the main Home Center screen
-  Displays the Status Monitor
-  Displays a Help panel for the Home Center software

AiO Home Center (Macintosh)

The AiO Home Center software is an application that runs on the computer. It enables you to configure your All-in-One printer from the computer. After installation, you can run Home Center from the System Preference's **Print & Fax** pane by selecting your Kodak All-in-One printer in the Printer List, clicking the **Print Queue** button, and then clicking the **Utility** icon.

The Setup and Maintenance tabs let you:

- Configure Settings
- Print a Test Page
- Align the Printhead
- Run a Nozzle Health Check
- Clean the Printhead

Select: Provides a list of connected printers where you can select another printer.

Order Supplies: Connects you to a Kodak web site where you can order supplies online.

View/Hide Status: Opens a drawer that displays the configuration status of your Kodak All-in-One printer.

2 Getting Started

The following information will help you get started using your Kodak ESP 3 All-In-One printer.

Printer Location

It is important to find a good location for your Kodak ESP 3 All-in-One printer. Place the printer on a clean, flat surface, in a dry location and out of direct sunlight. Make sure the printer has proper ventilation.

Avoid areas where ventilation ducts, open doors or high traffic might expose the printer and paper to high levels of dust and debris. Airborne particles can affect picture quality.

Allow enough space on all sides of the printer to comfortably connect and disconnect cables, change the ink cartridges, and remove and load paper.

Printing a Demo Page

You can print a Demo Page that lists information about the features and capabilities of your Kodak ESP 3 All-in-One printer.

To print a Demo Page from the printer control panel, press and hold **Copy** and **Scan** at the same time for 5 seconds.

Status Monitor (Windows Only)

The status monitor provides information such as printer status, messages, warnings, ink levels, printer response, and can be used to perform maintenance.



When the status monitor is active, a small printer icon appears in the system tray area of the Windows taskbar.



If an error occurs, the icon changes appearance.

Setting Options for the Status Monitor

You can specify how you want the status monitor to appear when you are printing from the computer.

- 1 In the Windows taskbar, right-click the printer icon. A menu appears.
- 2 Select **Options** from the menu.
- 3 Select one of the following options:
 - Always display the status monitor
 - Only display the status monitor when errors occur

3 Handling and Loading Paper

You can use many different types and sizes of paper in your Kodak ESP 3 All-in-One printer, including letter paper, photo paper, transparencies, envelopes, cards, and labels. The printer automatically detects the size and type of photo paper you load in the paper tray, and then adjusts to generate the highest quality output for that paper.

For best results use KODAK Inkjet Papers. KODAK Inkjet Papers have been optimized to work with KODAK All-in-One Printers. They contain bar-coding to enable the printer to automatically detect the paper type and make adjustments to generate the highest quality output.

Loading an Original

When copying or scanning using the Kodak ESP 3 All-in-One printer, place your original directly on the scanner glass.

- 1 Lift the lid and place your original face down on the right front corner of the scanner glass. Notice the silver arrow pointing to the right front corner.



- 2 Press **Copy** or **Scan** on the control panel.
- 3 To copy or scan oversized originals, completely remove the lid from the printer. The printer functions normally with the lid removed.

To remove the lid, lift the lid to the open position, grasp the sides of the lid, and then gently pull the lid upward.



To replace the lid, insert the tabs on the hinge back into the appropriate slots.

Handling Paper

Use the following guidelines when handling paper.

- To avoid fingerprints, handle paper by the edges as much as possible.
- Avoid touching the glossy side of photo paper.
- Store paper flat, away from direct sunlight, and out of high-temperature environments (such as a vehicle parked in the sun).

Loading the Paper Tray

You can load the Kodak ESP 3 All-in-One printer with various types of paper ranging from 3 to 8.5 inches wide and from 5 to 14 inches long. The tray capacity is 100 sheets of 20 lb plain paper. You can also load labels and transparencies.

Note To avoid fingerprints, handle photo paper by the edges and avoid touching the glossy side of the paper.

- 1 Pull the paper tray all the way out until the paper guide flips up on the right side.

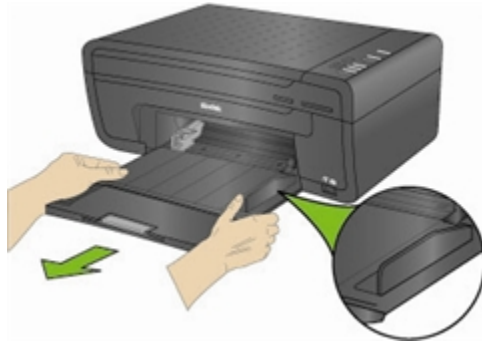

- 2 Slide the paper-width guide to its left-most position.
- 3 Align the edges of a stack of paper.
- 4 Insert the stack of paper into the paper tray with the print side down.



- 5 For paper less than 8.5 inches wide, squeeze the paper-width guide and slide it to the right until it lightly touches the stack of paper.

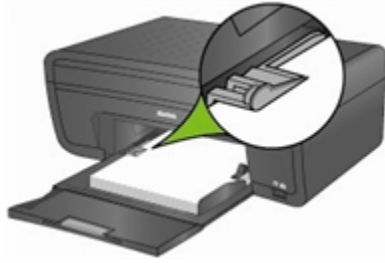

- 6 Leave the paper tray open when paper is loaded.
- 7 Before printing, pull the output tray extender all the way out and pop up the paper stop.

Loading 4 x 6 Photo Paper

You can load up to 30 sheets of 4 x 6 inch (101 x 150 mm) photo paper into the paper tray.

Note To avoid fingerprints, handle photo paper by the edges and avoid touching the glossy side of the paper.

- 1 Remove any other paper from the paper tray.
- 2 Insert the stack of photo paper into the right side of the paper tray with the short edge forward and the print side down. Do not overload the paper tray.



- 3 Slide the stack of paper forward until it stops.
- 4 Squeeze the paper-width guide and slide it to the right until it just touches the loaded paper.

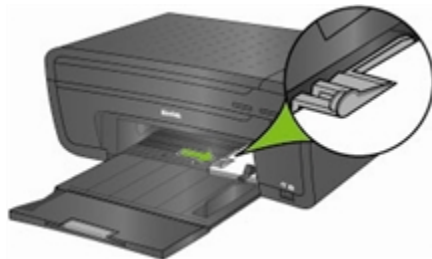

- 5 Leave the paper tray open while the paper is loaded.

Loading Envelopes

You can load plain envelopes into the paper tray of your Kodak ESP 3 All-in-One printer.

Important Do not use envelopes with cutouts or cellophane windows.

- 1 Remove any other paper from the paper tray.
- 2 Insert one or more envelopes into the right side of the paper tray with the print side down and the envelope flaps on the right, pointing left.



- 3 Squeeze the paper-width guide and move it to its right-most position up against the envelopes.
- 4 Leave the paper tray open while the envelopes are loaded.

4 Print

You can print pictures directly from a PictBridge camera or a Bluetooth device connected to your Kodak ESP 3 All-in-One printer. To print pictures from a PTP camera, mass storage device, or memory card, transfer the pictures to the computer and then print them from the computer.

Transfer Pictures to Computer

After you take pictures with your digital camera, you can transfer them to the computer and print them on your ESP 3 All-in-One printer. You can transfer .jpg, .mov, or .wav files to your computer from PictBridge cameras, memory cards, and USB mass storage devices.



Warning Do not attempt to remove a memory card from a slot while it is being accessed. Doing so can damage files on the card. You can safely remove a card only when the memory card status light is not blinking.

Transfer to a Windows computer

To transfer pictures from a PictBridge camera

- 1 On the front printer panel, connect a PictBridge camera to the USB port. The KODAK All-in-One Printer Software dialog open on the PC monitor.
- 2 On the KODAK All-in-One Printer Software dialog, select **Transfer my pictures** and click **OK**.
- 3 Complete the file transfer with Kodak EasyShare. If Kodak EasyShare is not installed, follow the instructions in the Scanner and Camera wizard to complete the transfer.

To transfer pictures from a memory card

- 1 On the front printer panel, insert a memory card into one of the memory card slots. The KODAK All-in-One Printer Software dialog open on the PC monitor.
- 2 On the KODAK All-in-One Printer Software dialog, select **Transfer my pictures** and click **OK**.
- 3 On the Select Device dialog, select the device you want to use and click **OK**.
- 4 Complete the file transfer with Kodak EasyShare. If Kodak EasyShare is not installed, follow the instructions in the Scanner and Camera wizard to complete the transfer.

To transfer pictures from a USB storage device

- 1 On the front printer panel, insert a USB storage device into the USB port. The KODAK All-in-One Printer Software dialog open on the PC monitor.
- 2 On the KODAK All-in-One Printer Software dialog, select **Transfer my pictures** and click **OK**.
- 3 On the Select Device dialog, select the device you want to use and click **OK**.
- 4 Complete the file transfer with Kodak EasyShare. If Kodak EasyShare is not installed, follow the instructions in the Scanner and Camera wizard to complete the transfer.

Transfer to a Macintosh computer

To transfer from a PictBridge camera

- 1 On the front printer panel, connect a PictBridge camera to the USB port.
- 2 When a transfer or connection message appears on your computer monitor, click **Yes**.
- 3 Complete the file transfer with Kodak EasyShare. If EasyShare is not installed on your computer, use iPhoto or Image Capture to complete the transfer.

To transfer from a memory card

- 1 On the front printer panel, insert a memory card into one of the memory card slots.
- 2 Complete the file transfer with Kodak EasyShare. If EasyShare is not installed on your computer, use iPhoto or Image Capture to complete the transfer.

To transfer from a USB storage device

- 1 On the front printer panel, insert a USB storage device into the USB port.
- 2 Complete the file transfer with Kodak EasyShare. If EasyShare is not installed on your computer, use iPhoto or Image Capture to complete the transfer.

Print Pictures from a PictBridge Camera

You can print pictures on your Kodak ESP 3 All-in-One printer directly from a PictBridge camera. The camera controls the photo selection and printing.

- 1 Load the paper tray with photo paper, print side down.
- 2 Connect a PictBridge camera to the USB port. The first photo is displayed on the camera.
- 3 Use your PictBridge camera to select and print the pictures.

Print from a Bluetooth Device

The Kodak ESP 3 All-in-One printer allows you to print from a Bluetooth device. Bluetooth is a short-range radio technology that allows wireless connectivity between electronic devices.

Bluetooth connectivity is supported using an optional Kodak USB Bluetooth Adapter that accepts JPEG/EXIF image file types. You can purchase a Bluetooth Adapter directly from Kodak at www.kodak.com/go/accessories.

To enable Bluetooth wireless connectivity, plug your Kodak Bluetooth Adapter into the front USB port. When a Bluetooth device is connected and actively printing the only other functions available are **On/Off** and **Cancel**. When connected, you can send pictures from your Bluetooth device. Your Kodak ESP 3 All-in-One printer supports connection to only one Bluetooth device at a time and has an 8 MB file size limitation.



The following types of Bluetooth-enabled devices are supported:



Mobile camera phones
PDAs
Digital still cameras
Computers

Range

The recommended maximum distance between Bluetooth devices for the highest transfer speed is 10 meters or 32.81 feet. However, Bluetooth will work beyond this distance.

Bluetooth Name

Your Kodak ESP 3 All-in-One printer has a serial number that is used to construct a name for Bluetooth printing. The default name is **Kodak ESP-3+XXXX**, where **XXXX** represents the last four digits of the printer's serial number. You can change this to a more meaningful name with the Kodak Home Center configuration feature.

Panoramic Photos

Panoramic photos are images with an aspect ratio of 1 : 1.77 or greater. Load 4 x 12 photo paper to print panoramic photos as a 1 up layout. Load US Letter or A4 photo paper to print panoramic photos as a 2 up layout.

Print Layouts

You can print multiple picture layouts from a PictBridge camera. The table below shows the print sizes that result from the various layouts when applied to US letter-size paper (8.5 x 11 inches).

Layout	A Paper Print Size
Borderless	8.5 x 11 inches
Bordered	8 x 10 inches
2 per page	5 x 7 inches
3 per page	4 x 6 inches
4 per page	3.5 x 5 inches
9 per page	2.5 x 3.25 inches (wallet)

In addition to US Letter size paper, your Kodak ESP 3 All-in-One printer provides picture layout support for the following US and ISO 216 international paper sizes.

- 4 x 6 inches
- 5 x 7 inches
- 8 x 10 inches
- A4 (21 x 30 centimeters)

4x6 Inch Paper

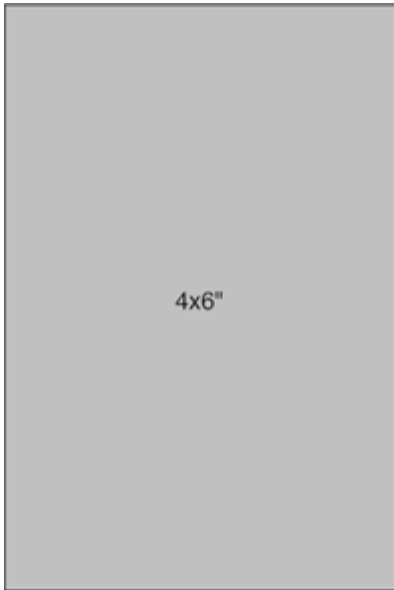

4x6"

1 per page borderless

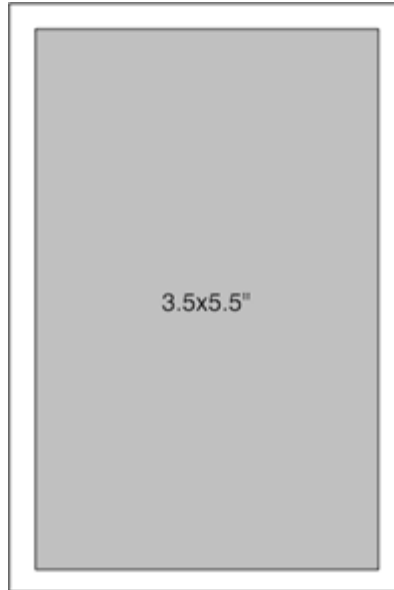

3.5x5.5"

1 per page bordered

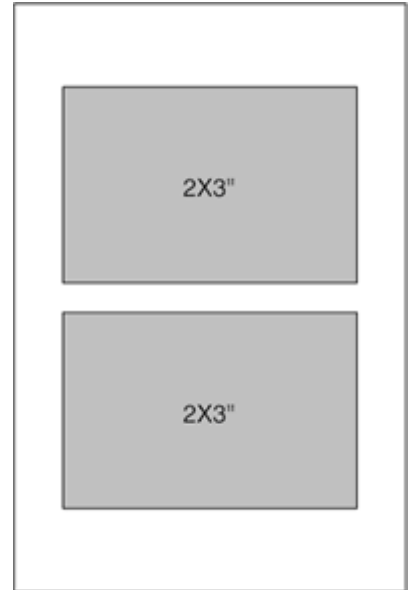

2X3"

2X3"

2 per page

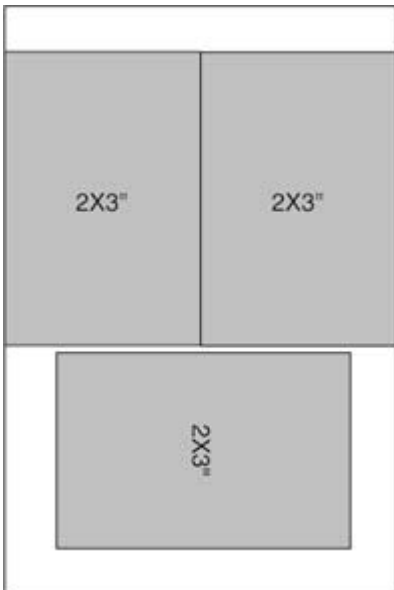

2X3"

2X3"

2X3"

3 per page



2X3"

2X3"

2X3"

2X3"

4 per page

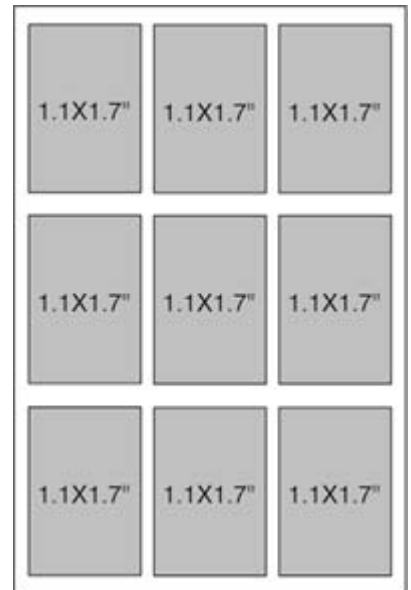

1.1X1.7"

1.1X1.7"

1.1X1.7"

1.1X1.7"

1.1X1.7"

1.1X1.7"

1.1X1.7"

1.1X1.7"

1.1X1.7"

9 per page

5x7 Inch Paper

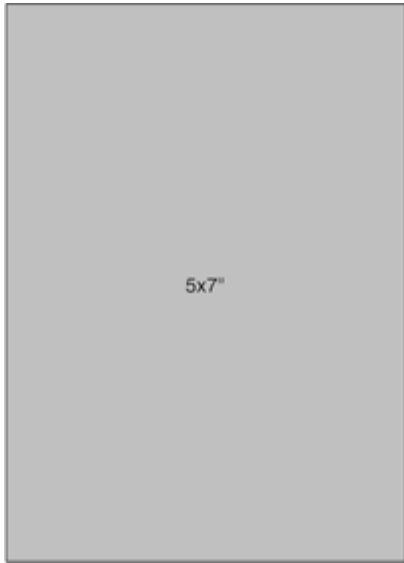

1 per page borderless

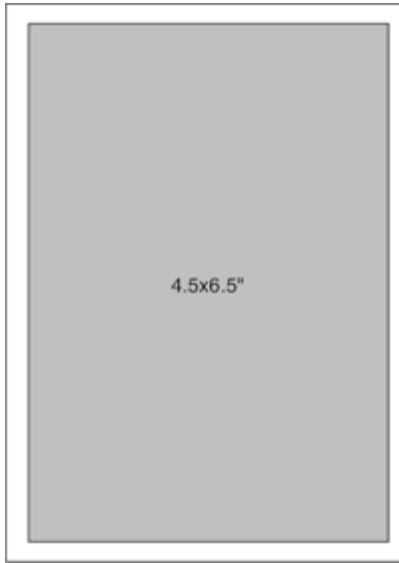

1 per page bordered



2 per page

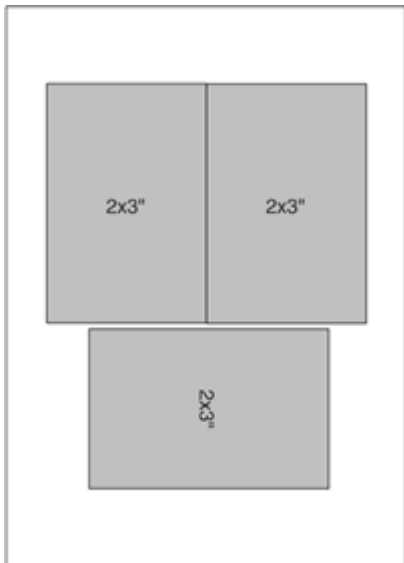

3 per page

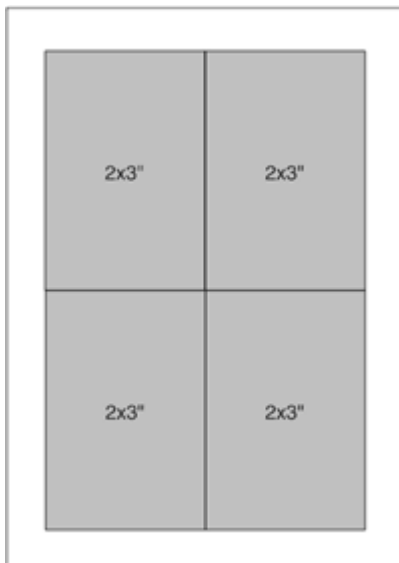

4 per page

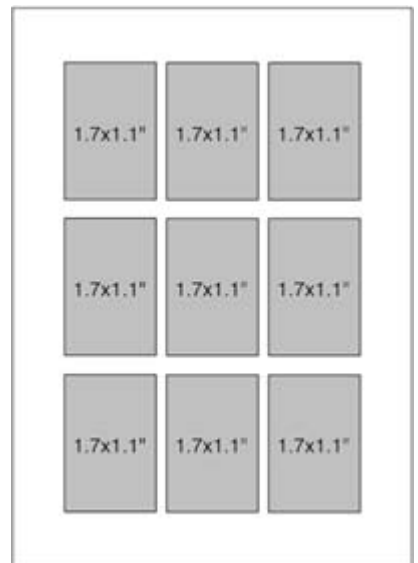

9 per page

8x10 Inch Paper

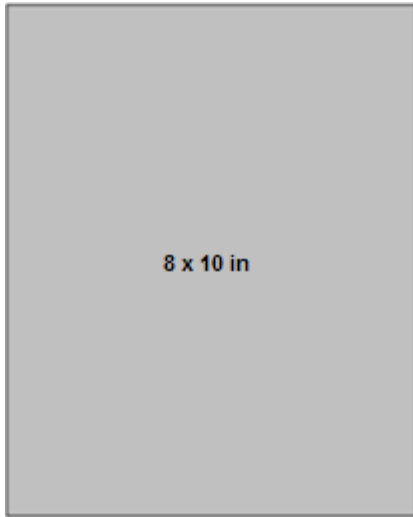

1 per page borderless

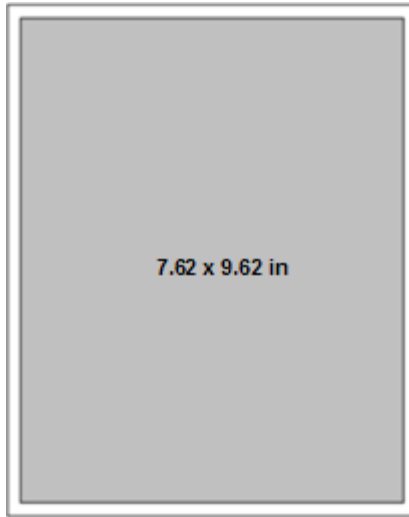

1 per page bordered

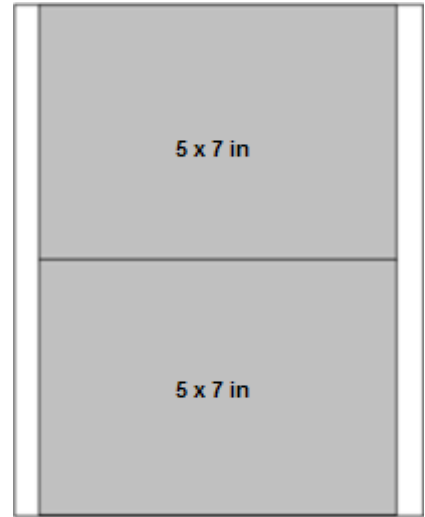

2 per page

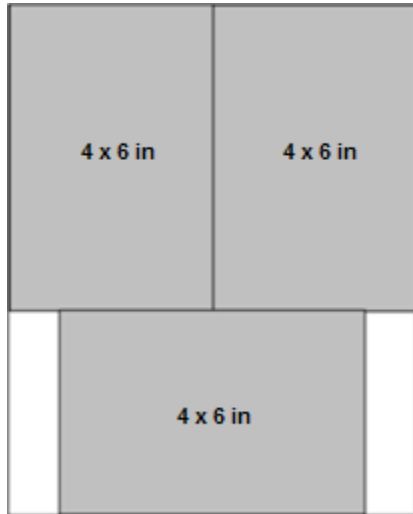

3 per page

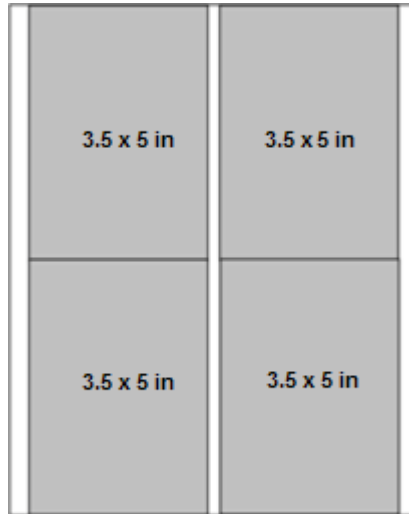

4 per page

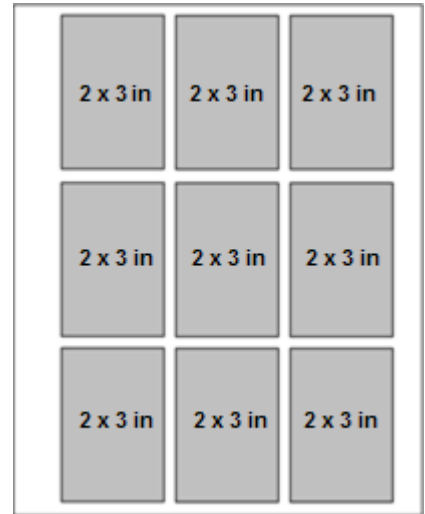

9 per page

US Letter

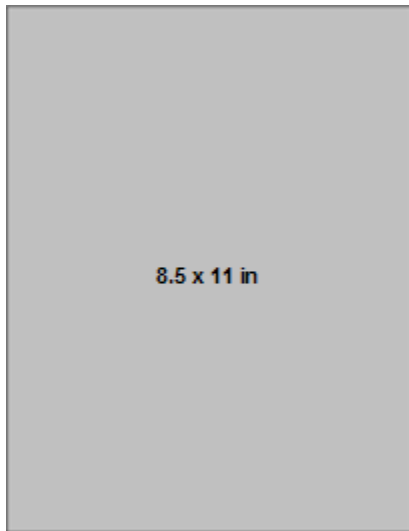

1 per page borderless

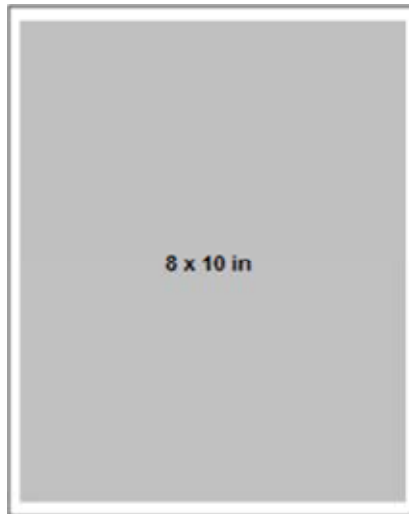

1 per page bordered

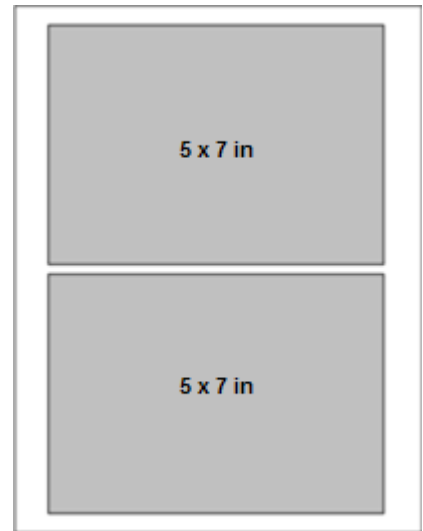

2 per page

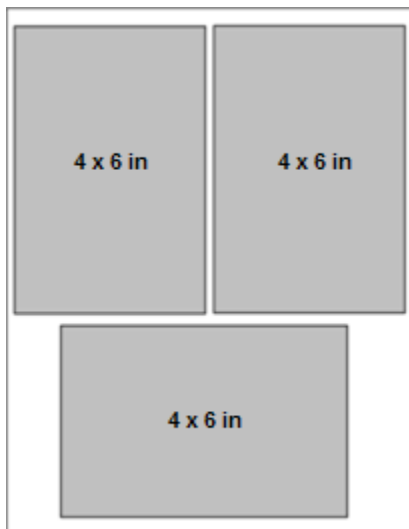

3 per page

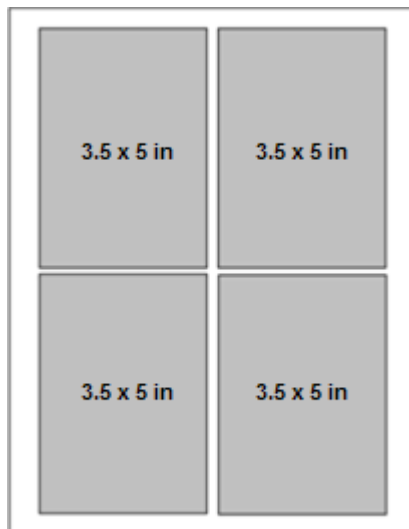

4 per page

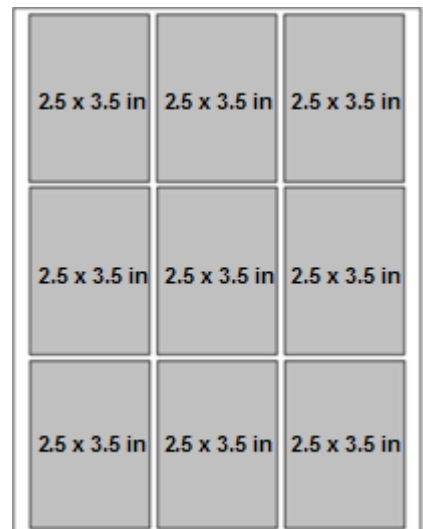

9 per page

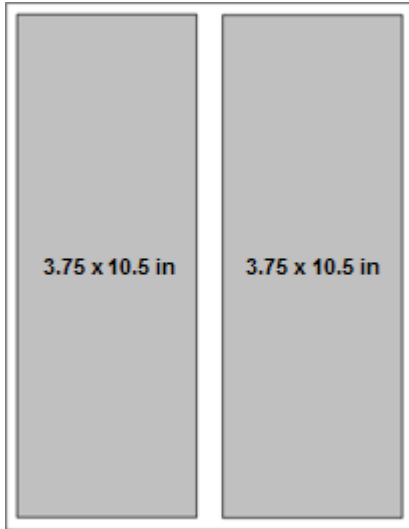

Panoramic

A4 Paper



1 per page borderless



1 per page bordered

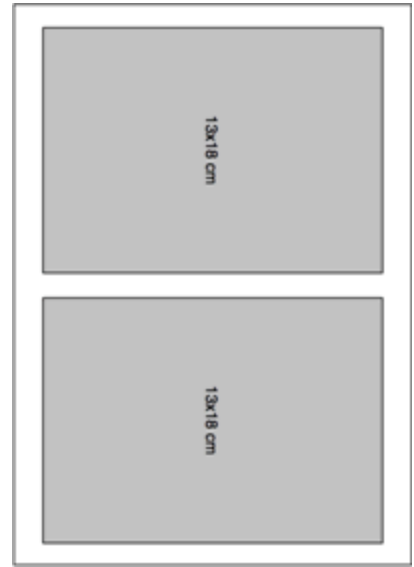

2 per page

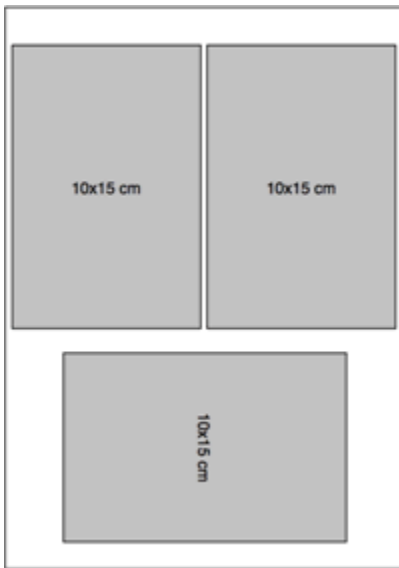

3 per page

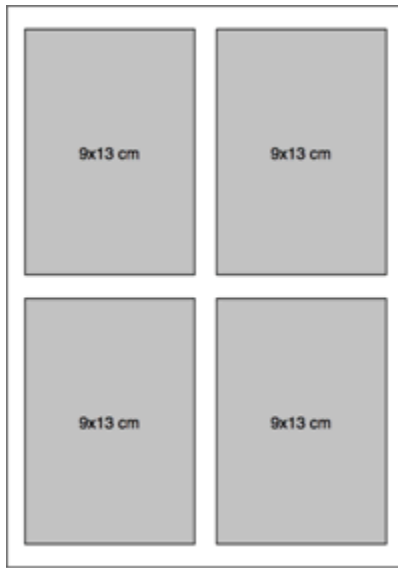

4 per page



9 per page

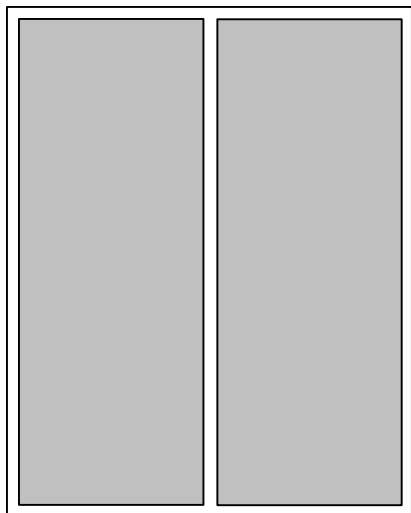

Panoramic

4 X 12 Paper

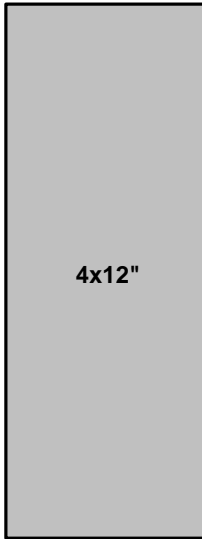

Panoramic
Borderless

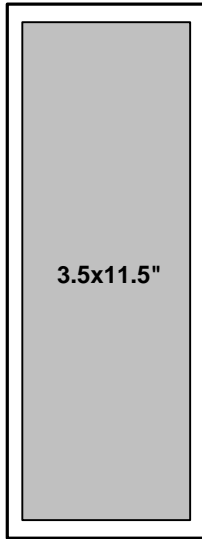

Panoramic
Bordered

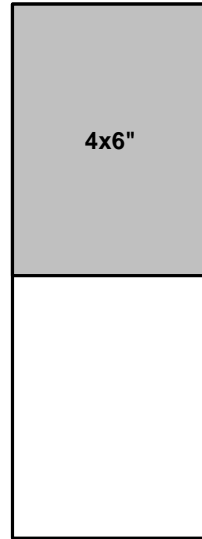

Non-panoramic
Borderless

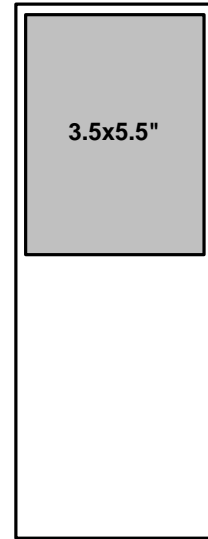

Non-panoramic
1 per page

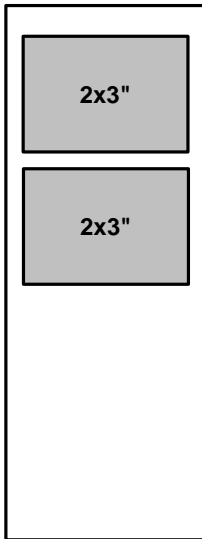

Non-panoramic
2 per page

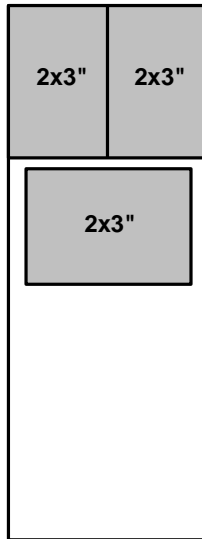

Non-panoramic
3 per page

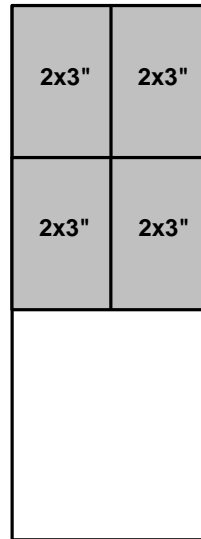

Non-panoramic
4 per page

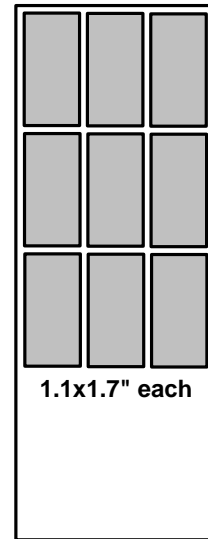

Non-panoramic
9 per page

7 Copy

You can copy both pictures and documents directly from the control panel of your Kodak ESP 3 All-in-One printer. The printer produces high-quality color and black & white copies on a variety of paper types, including transparencies.

To copy one original

- 1 Place your original face down on the right front corner of the scanner glass.
- 2 Press **Quantity** on the control panel to select the number of copies.
- 3 Press **Copy Print Size** to select **100%** or **Fit to Page**.

100% produces a 1 : 1 copy. When the paper loaded is smaller than the original, the copy is cropped.

Fit to Page produces a 1 : 1 copy only when the original is the same size as the paper loaded. When the paper loaded is smaller than the original, the original is reduced to fit on the smaller paper size. When the paper loaded is larger than the original, the original is expanded to fill the larger paper size. In either case, the image is scaled such that one dimension of the image fits one dimension of the paper, and the image is cropped on the other dimension. No white space is left of the page.

- 4 Press **Copy Color** to select Color or Black & White copies.
- 5 Press **Copy**.

To copy multiple pictures to A4 or Letter size paper

- 1 Load the paper tray with A4 or Letter size photo paper.
- 2 Place more than one picture face down on the scanner glass.
- 3 Press **Quantity** on the control panel to select the number of copies.
- 4 Press **Copy Color** to select Color or Black & White copies.
- 5 Press **Copy**.

Scan

Scanning is the process of converting text and pictures into an electronic format for your computer. The Scan mode becomes active when you press **Scan**. The Scan status light is always on when your All-in-One printer is in Scan mode. To use the scan features, your All-in-One printer must be connected to a computer.

Important Use the Kodak AiO Home Center software to configure scan settings for the control panel.

Scan from Control Panel (Windows)

To scan to a file

- 1 Set the **Default scan destination** to **File** with the Kodak Home Center software (see Home Center Help).
- 2 Place your original face down in the right front corner of the scanner glass.
- 3 Press **Scan**. The original is scanned and saved to a file on your computer according to the scan settings in the Kodak Home Center software.

To scan to an application

- 1 Set the **Default scan destination** to **Application** with the Kodak Home Center software (see Home Center Help).
- 2 Place your original face down in the right front corner of the scanner glass.
- 3 Press **Scan**. The original is scanned into Kodak Home Center where you can open it with the application of your choice.

Scan from Control Panel (Macintosh)

To scan to a current settings name and location

- 1 Set the **Scan Destination** to **File** with the Kodak Home Center software (see Home Center Help).
- 2 Place your original face down in the right front corner of the scanner glass.
- 3 Press **Scan**. The original is scanned and saved to a file on your computer according to the scan settings in the Kodak Home Center software.

To scan and select name and location

- 1 Set the Scan Destination to Application with the Kodak Home Center software (see Home Center Help).
 - 2 Place your original face down in the right front corner of the scanner glass.
 - 3 Press **Scan**.
 - 4 Select a destination from the Save dialog on the computer.
-

Maintenance

This section provides maintenance information for the Kodak ESP 3 All-in-One printer.

The Kodak ESP 3 All-in-One printer requires little maintenance. However, you should regularly clean the scanner glass and lid backing to remove dust and fingerprints. Fingerprints and other debris on the glass or lid backing could slow down performance and affect the accuracy of scanning.

General Care

Important Always disconnect the power on the Kodak ESP 3 All-in-One printer before cleaning. Do not use harsh or abrasive cleaners or organic solvents on the printer or any of its parts.



Warning Do not leave items on the scanner glass. The heat of the scanning lamp may cause them to stick.

- To clean, wipe the outside of the printer with a clean, dry cloth.
 - Keep the surrounding area vacuumed and litter-free.
 - Protect the printer from tobacco smoke, dust, sand, and liquid spills.
 - Avoid placing objects on the printer.
 - Keep the printer, accessories, and supplies away from direct sunlight and out of high-temperature environments.
 - Do not allow chemicals, such as suntan lotion, to come into contact with the painted surface of the printer.
 - If the printer has been subjected to inclement weather or you suspect water has gotten inside the printer, turn it off and let it dry out. If this does not resolve the problem, contact customer support (see *Telephone Customer Support*).
 - Service agreements are available in some countries. Contact a dealer of Kodak products for more information.
 - For more recycling and or disposal information, contact your local authorities. In the US, visit the Electronics Industry Alliance Web site at www.eiae.org.
-

Cleaning the Scanner Glass

To ensure that your copies and scans remain clear, keep the Kodak printer's scanner glass and lid backing clean and dust the exterior.



Warning Do not use abrasives, acetone, benzene, or carbon tetrachloride on the glass, since they can damage it. Do not place or spray liquid directly on the glass. The liquid might seep under the glass and damage the device.

- 1 Unplug the printer and raise the lid.
- 2 Clean the glass with a soft cloth or sponge slightly moistened with a nonabrasive glass cleaner.
- 3 Dry the glass with a lint free cloth.
- 4 When finished cleaning, plug in the printer.

Cleaning the Scanner Lid

Minor debris can accumulate on the document backing located underneath the scanner lid of the Kodak printer.



Warning Do not use paper-based wipes, as these might scratch the underside. Do not use harsh or abrasive cleaners or organic solvents on the printer or any of its parts.

- 1 Unplug the printer and raise the lid.
- 2 Clean the lid underside with a soft cloth or sponge slightly moistened with a mild soap and warm water.
- 3 Wipe the underside gently to loosen debris. Do not scrub.
- 4 Dry the underside with a chamois or soft cloth.
- 5 If further cleaning is needed, repeat the previous steps using isopropyl (rubbing) alcohol, and wipe the underside thoroughly with a damp cloth to remove any residual alcohol.
- 6 When finished cleaning, plug in the printer.

Printing a Test Page

The test page provides information about your printer that can be useful when contacting Kodak support (see *Support* and *Telephone Customer Support*).

The test page can be printed directly from the control panel. It is formatted for US letter or A4 size plain paper and will not work on smaller paper.

- 1 Load the paper tray with US letter or A4 size plain paper
- 2 On the control panel, press and hold **Quantity** and **Cancel** at the same time until the **On/Off** light starts blinking.

Ink Cartridges

Your Kodak printer uses separate black and color ink cartridges. The ink levels show on the control panel and in the printer software. When replacing, use genuine Kodak ink cartridges to ensure best results and avoid printhead damage not covered under warranty.

Checking Ink Levels

You can easily check the ink levels to determine how soon you might need to replace an ink cartridge. The control panel has two ink level indicators under the **On/Off** button, one for the black ink cartridge and one for the color ink cartridge. These indicators blink very slowly when ink levels are low, and fast when the ink cartridge should be replaced or need attention.

Replacing Ink Cartridges

Important For the best quality prints, store ink cartridges in a location where the temperature does not exceed 85°F (30°C).



Warning Use genuine Kodak ink cartridges to ensure best results and avoid printhead damage not covered under warranty. Third-party ink cartridges may not contain the necessary Smart Chip information to notify you before the ink cartridge is empty.

- 1 Make sure the printer is on.
- 2 Open the printer access door by lifting from the front center of the unit. The printhead moves to a center position. The ink tanks are located in the printhead.

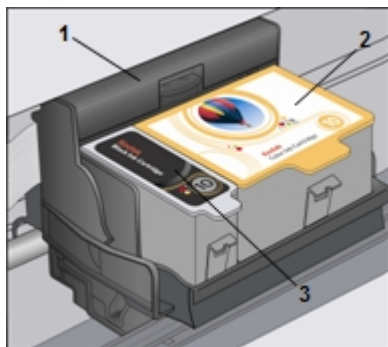

- 1 Printhead
- 2 Color ink cartridge
- 3 Black ink cartridge

- 3 Wait until the printhead is idle and silent, then pinch the latch on the old ink cartridge with your thumb and forefinger and lift it out of the printhead.



Note You can take your used ink cartridges to most office supply or electronics stores for safe disposal.

- 4 Open the box containing the new ink cartridge.

- 5 Remove the bagged ink cartridge from the box, **tear open the bag at the notch**, and remove the ink cartridge.

Important Insert the ink cartridge immediately to prevent any drying of the ink.



- 6 Remove the orange cap from the cartridge by grasping the top edge and pulling/rotating it off the ink cartridge. Discard the orange cap.



- 7 Insert the ink cartridge into the printhead.

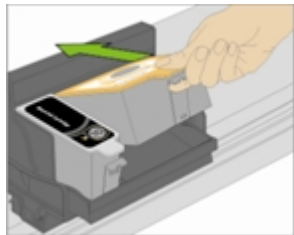

- 8 Press down on the tab until you hear a click and feel the latch snap into position.

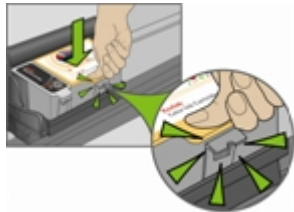

- 9 Close the printer access door. The printhead moves to its ready position.

Printhead

The printhead dispenses the ink from the ink cartridges onto the paper.

Printhead Alignment

The printhead may need to be aligned to enable high-quality prints. The Kodak printer automatically performs a calibration every time you install or replace a printhead. You can also initiate a printhead alignment from the ESP 3 printer driver, Home Center software, or control panel.

To align the printhead from the control panel

- 1 Load the paper tray with US letter or A4 Kodak plain paper.
- 2 On the control panel, press and hold **Scan** and **Cancel** at the same time until the **On/Off** light starts blinking. The following pattern is printed and calibration is complete when the page is printed.

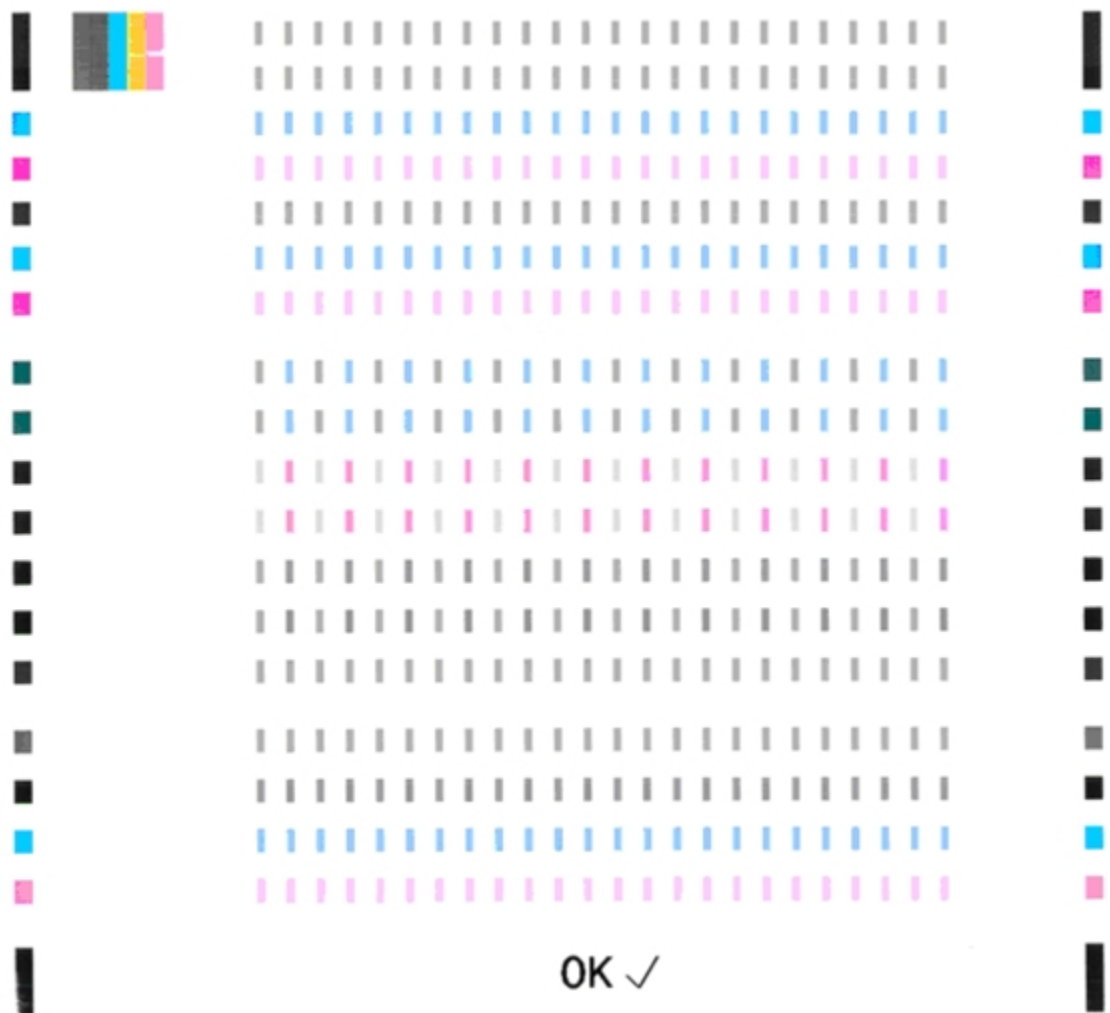

Clean Printhead

Run a printhead cleaning if color is faded or missing by pressing and holding **Copy** and **Cancel** at the same time.

Replace the Printhead

If your printhead is damaged or broken it is easy to replace yourself.

- 1 Make sure the Kodak ESP 3 All-in-One printer is on.
- 2 Open the printer access door.



- 3 Pinch the latch on the ink cartridge with your thumb and forefinger and lift it out of the print head. Remove both ink cartridges.

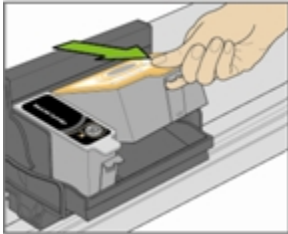

- 4 Unlatch the printhead by pressing by pressing the release button on the top center of the carriage.



- 5 Remove the old printhead from the carriage.



- 6** Remove the new printhead from its bag.



- 7** Remove and discard the black plastic casing and the orange protective cap.



- 8** Place the new printhead into the carriage.



- 9** Push firmly against the target label on the printhead until it clicks into place.



- 10** Reinstall the ink cartridges.

- 11** Close the printer access door. A calibration page automatically prints.
-

8 Support

Contact Kodak

Kodak provides several resources to help you solve problems with your Kodak printer.

- Troubleshooting information (see Troubleshooting).
- Additional technical information (in the ReadMe file located on the Kodak EasyShare software CD).
- Support from the Kodak Web site (www.kodak.com/go/aiosupport).
- Update the Kodak Home Center software (www.kodak.com/go/downloads).
- Update the printer and scanner driver software (www.kodak.com/go/downloads).

Support	Description	Internet URL
General	Resource Center	www.kodak.com/go/resourcecenter
Printer	Get support for your product (FAQs, troubleshooting information, etc.).	www.kodak.com/go/faqs
	Purchase a full range of digital camera and printer accessories.	www.kodak.com/go/accessories
	Download latest printer software, firmware, and drivers.	www.kodak.com/go/downloads
	Online tutorials.	www.kodak.com/go/howto
Software	Get information on Kodak EasyShare software.	www.kodak.com/go/easysharesw or click the Help  button in the EasyShare software
	Get help with the Windows operating system and working with digital pictures.	www.kodak.com/go/pcbasics
Other	Get support for Kodak printers, cameras, software, accessories, more. Print a Test Page before contacting Kodak support (see <i>Printing a Test Page</i>).	www.kodak.com/go/support
	Register your printer.	www.kodak.com/go/register

Troubleshooting

Printer Fails to Power On

Probable Cause

The power supply is not properly connected.

Corrective Action

- Make sure the power cord is connected to the power supply and plugged into a grounded power outlet or power strip.
- If you are using a power strip, make sure it is turned on.
- If you are using a switched power outlet, make sure the switch is on.
- Make sure the power outlet is supplying power.
- If none of the above corrects the problem, contact Kodak support.

Device not Recognized

Probable Cause

Any of the following can prevent your Kodak printer from reading a connected digital camera, USB thumb drive, or memory card.

- The camera is turned OFF.
- The USB connector from the camera is not fully inserted in the port.
- The memory card is not completely inserted.
- The memory card is in backwards.
- The memory card file system is corrupt.
- Make sure camera is in "connect" mode (PTP).
- More than one memory card inserted.
- The USB device is not supported.

Corrective Action

- Correct any connection problems and try again.
- If the memory card file system is corrupt, reformat it in your camera.
- Disconnect the unsupported device.

Ink Cartridge Not Recognized

Probable Cause 1

Generic or non-Kodak ink cartridges may not function in the KODAK EASYSHARE All-in-One Printer. Kodak recommends using Kodak ink cartridges.

Corrective Action

Install a genuine Kodak ink cartridge.

Probable Cause 2

One of the ink cartridges has expired and needs to be replaced.

Corrective Action

Replace the expired ink cartridge.

Multiple Paper Feed

Probable Cause

Multiple sheets of paper were pulled through printer.

Corrective Action

Important KODAK Inkjet paper is recommended for your Kodak All-in-One printer.

- 1 Remove the paper from the paper tray.
- 2 Carefully "fan" the paper to keep the sheets from sticking together.
- 3 Reload the paper tray. Do not overfill.
- 4 Press **Copy** to continue or **Cancel** to stop.

Multiple Pictures Not Scanned Properly

When scanning or copying, the Kodak printer can detect multiple pictures on the scanner glass, straighten them, and create individual files. If you are having trouble with this feature, check the following:

Probable Cause 1

Your pictures are not placed optimally on the scanner glass.

Corrective Action

- Make sure that your pictures do not overlap.
- Place pictures away from the edges of the scanner glass.
- Some images do not scan well. Light-colored images may not be detected as separate images.
- You may need to make adjustments to the scanning area using the Preview feature in the Kodak Home Center.

Probable Cause 2

The scanner glass is dirty.

Corrective Action

Make sure the scanner glass is completely clean or the pictures might not scan properly (see *Cleaning the Scanner Glass*).

Probable Cause 3

The scanner lid is dirty.

Corrective Action

Clean the scanner lid (see *Cleaning the Scanner Lid*).

No Communication with Computer

Probable Cause

Your Kodak printer is not connected to your computer.

Corrective Action

- Make sure your printer is plugged in and turned on.
- Make sure you are using the proper USB cable.



- Check the connection from your computer to your printer. Ensure that the square end of the USB cable is plugged in to the USB port on the back of your printer, and the flat end into a USB port on your computer.

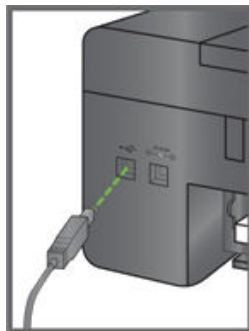

- You may need to disconnect other printers or scanners from your computer.
- After checking connections, restart your computer.
- Make sure your computer meets the minimum system requirements. Upgrade your system if necessary.

For more information on connecting your printer to your computer, see the Setup Guide that came with your printer.

No Paper Feed

Probable Cause

The paper tray may be empty, or there may be a problem with the paper in the tray.

Important KODAK Inkjet paper is recommended for your Kodak All-in-One printer.

Corrective Action

If the tray is empty, load paper into the paper tray, then resume printing. Check for a message on the printer status monitor (Windows) on your computer. Check for a problem with the paper in the tray.

To check the paper

- 1 Inspect the paper and make sure no paper sheets are damaged in any way. Reload with new paper, if necessary.
- 2 Carefully "fan" the paper to keep the sheets from sticking together.
- 3 Reload the paper tray. Do not overfill.
- 4 Press **Copy** to continue or **Cancel** to stop.

Paper Jam

Probable Cause

The paper did not advance, was not picked up properly from the paper tray, or is lodged inside the printer.

Important Kodak Inkjet paper is recommended for your Kodak All-in-One printer.

Corrective Action

- 1 Remove the paper from the tray.
- 2 Turn off the printer.
- 3 In the rear access area, pull the paper out from the rollers without tearing it.
Important If the paper tears while removing it, make sure you remove all the torn pieces. More jams are likely to occur when torn pieces are left in the printer.
- 4 Reload the paper tray. Do not overfill.
- 5 Turn the printer on.
- 6 Press **Copy** to continue or **Cancel** to stop.

Printer not Responding

Probable Cause

The firmware or software is not in a ready state.

Corrective Action

- Turn the printer off and turn it back on.
 - If the problem persists, unplug the power cord from the power supply and plug it back in.
-

- If the problem continues to persist, restart your computer.

Transfer Pictures Failure

Problem

Nothing happens when you try to transfer pictures to the computer.

Corrective Action

- Wait a few moments for the image files to be read.
- Remove the memory card or USB device and reinsert it.
- Check the power connection to the computer.
- If you are trying to transfer pictures from a memory card and a PictBridge camera is connected, remove it.
- Close unnecessary software applications, and minimize remaining application windows. Follow any messages on the screen that may have been hidden by other windows.
- Disconnect then reconnect the USB cable from the printer to the computer.
- Make sure you are using the USB cable included with your printer.
- Make sure your computer meets the minimum system requirements for using your printer (see *System Requirements*). Upgrade your system if necessary.

Note The Kodak printer is compatible with the Kodak 8-in-1-card reader (sold separately). Other Kodak USB card readers may work with the printer, however, other manufacturers' card readers are not supported.

Wrong Paper Size

Probable Cause

The paper you selected may be larger or smaller than the paper found in the paper tray.

Corrective Action

- 1 Replace the paper in the paper tray with the correct size.
- 2 Press **Copy** to continue or **Cancel** to stop.
- 3 If the situation continues, contact *Kodak support*.

Print Troubleshooting

Use this section to resolve print problems.

Envelope Printing Incorrect

Probable Cause

The envelopes are not loaded correctly.

Corrective Action

- 1 Remove the envelopes from the paper tray.

- 2 Straighten the stack of envelopes against a flat surface, and reload the stack into the paper tray with the flap on top and on the right.
- 3 Squeeze the paper guide and slide it to the right until it touches the edge of the envelopes.

Multiple-page Document in Reverse Order

Probable Cause

The printing settings in the printer driver are set to print the first page of your document first.

Corrective Action

Configure the printer driver to print the document in reverse order so the pages will be in the correct order when printing is complete.

To set a Windows PC to print in reverse order

- 1 Open Printers and Faxes.
- 2 Select your Kodak All-in-One printer in the **Name** column.
- 3 Click on **Select printing preferences** on the Printer Tasks list.
- 4 On the General tab, select **Print last page first**.

To set a Macintosh to print in reverse order

- 1 On the File menu, select **Print**.
- 2 On the Print dialog, select **Paper Handling**
- 3 Select the **Reverse** Page Order option.

PictBridge Camera not Detected

- Check the USB connections from the PictBridge compatible camera or device to the printer.
- If disconnected, reconnect the USB cable from the PictBridge compatible camera or device to the printer.
- Make sure there is at least one picture in the PictBridge compatible camera or device's internal memory or memory card.
- Make sure the connected camera or device is PictBridge compatible. See your camera or device user's guide for details.
- Check the camera batteries.

Picture Cropped

- Change the picture quality setting (or resolution) on your digital camera to 3:2. See your camera user's guide for details.
 - Adjust cropped pictures using the Kodak Home Center or other image editing software on your computer.
 - If you are printing from an application on your computer, select the proper paper size from the printer options.
-

Note Cropping may vary depending on the selected picture size and size of the output paper. The dimensions of the photo on the camera are slightly different than each paper size so a portion will be cropped to fit perfectly on whatever paper size was selected.

Picture Print Smudged

Probable Cause

Fingerprints may be on glossy side of paper.

Corrective Action

Handle paper by the edges.

Picture Will Not Print

A selected picture does not print.

- The image file may be corrupt. Review the picture on the camera or computer and delete, if necessary.
- The image file may not be JPEG format. The Kodak printer can print only JPEG files in stand-alone mode. Connect to a computer and use software to print other image formats.

Poor Print Quality

- Low resolution image file.
- Align the printhead (see *Alignment*).
- Perform a nozzle check with the Home Center software.
- Clean the printhead (see *Cleaning the Printhead*). If the printhead is clogged, the printouts should begin to improve with two or three cleanings. Repeat the cleaning cycle until the printout stops improving.
- If the problem still persists, you may need to replace the printhead.

Print Skewed or Slanted

Probable Cause 1

The paper is not properly loaded in the tray.

Important KODAK Inkjet paper is recommended for your Kodak All-in-One printer.

Corrective Action

Realign the paper in the paper tray.

- 1 Remove paper and check for wrinkles and tears.
- 2 Slide the paper guide away from the paper.
- 3 Straighten the stack of paper against a flat surface, and reload it into the paper tray.
- 4 Slide the paper guide up against the edge of the paper.

Probable Cause 2

More than one type of paper is loaded.

Corrective Action

Load only one type of paper.

Print Spotted

Probable Cause

Paper may be dirty.

Corrective Action

Use a dry, lint-free cloth to wipe clean. For excessive dirt or debris, thoroughly clean the paper tray, and load new paper.

Note Keep paper tray covers closed to keep dust and debris from collecting on the paper or inside the printer.

Print Too Dark

- Try retaking the picture with the flash on, or move within the flash range of the camera. Refer to your camera user's guide for details.
- Adjust the exposure compensation on your camera, and try taking the picture again. Refer to your camera user's guide for details.
- Edit the picture using Kodak Home Center or other image editing software.
- Make sure the printer is not placed in direct sunlight or is not operating in a high-temperature environment.

Print Too Light

Important For best results, use Kodak ink cartridges and paper for your printer.

- Make sure the paper is loaded with the Kodak logo facing up. Reload if necessary.
- Try taking the picture again with the flash off. Refer to your camera user's guide for details.
- Adjust the exposure compensation on your camera, and try taking the picture again. Refer to your camera user's guide for details.
- Edit the picture using Kodak Home Center or Kodak EasyShare software on your computer. Refer to the Home Center or EasyShare software Help for details.

Printing Slow

Note When printing a large number of prints, printing may slow down to prevent the printhead from overheating.

- Make sure the printer is not placed in direct sunlight or is not operating in a high-temperature environment (higher than 95° F, or 35° C).
 - Close unnecessary software applications.
-

- Make sure your computer meets the minimum system requirements. Upgrade your system if necessary

Printing Stops

Printing stops during mid-print. Paper stops feeding, and status light may blink.

Important For best results, use Kodak ink cartridges and paper for your printer.

To check the paper

- 1 Remove any loose paper from the printer. Check the paper access door in the rear of the printer.
- 2 Inspect the paper supplies and reload with new paper, if necessary.
- 3 Carefully "fan" the paper to keep the sheets from sticking together.
- 4 Reload the paper tray. Do not overload.
- 5 Press **Copy** to continue or **Cancel** to stop

White Edges on Borderless Prints

Probable Cause 1

White edges can appear when there are slight misalignments between the printer and paper. Some software applications are able to "hide" these small misalignments so that the prints look borderless like they are supposed to.

Corrective Action

- Realign the paper in the tray.
- Use the application's **Fit to Page/Fill Page** option, or resize the picture so it is slightly larger than the paper size.

Probable Cause 2

If the image's proportions or dimensions are not compatible with the selected paper size, the print usually will not be borderless. For example, if a square image is printed onto 4 x 6 inch paper, it will often print as a 4 x 4 inch image, with white edges on each side of the print.

Corrective Action 2

Crop the image so it is compatible with the selected paper size.

Copy Troubleshooting

Use this section to resolve the following copy problems.

Copy Cut Off

Probable Cause

The original is larger than the paper loaded.

Corrective Action

When the original is larger than the paper loaded, use the **Fit to Page** feature to reduce copy size to fit the size of the paper loaded.

Scan Troubleshooting

Scan Fails

Probable Cause 1

Your computer is not turned ON.

Corrective Action

Turn on your computer.

Probable Cause 2

Your Kodak printer is not connected to your computer.

Corrective Action

Connect your Kodak printer to your computer with a standard USB cable.

Probable Cause 3

The Kodak Home Center software is not installed.

Corrective Action

Insert the Kodak printer installation CD and install the software.

Probable Cause 4

Your computer system resources may be low.

Corrective Action

- Turn off your computer and the printer, and then turn them back on.
- If the problem still persists, try scanning at a lower resolution.

Scanned Image Blank

Probable Cause

Your original is not placed correctly on the scanner glass.

Corrective Action

Place your original face down in the proper corner of the scanner glass.

Kodak ESP 3 All-in-One Printer Specifications

The following feature specifications are for the Kodak ESP 3 All-in-One printer.

Print performance	
Black print speed	Up to 30 ppm on plain paper
Color print speed	Up to 29 ppm on plain paper
Photo print speed	Up to 2.18 ppm (as little as 30 seconds per print) on 4 x 6 inch (10 x 15 cm) borderless Kodak watermark photo paper
Print technology	Continuous-tone thermal ink jet
Print quality modes	Draft, Normal, and Best on plain paper Photo quality on photo paper

Printing features	
Borderless sizes supported	4 x 6 inch (10 x 15 cm) 4 x 8 inch (10 x 20 cm) 4 x 12 inch. (10 x 30 cm) 5 x 7 inch (13 x 18 cm) 6 x 9 inch (15 x 23 cm) 8 x 10 inch (20 x 25 cm) US Letter (8.5 x 11 inch) (22 x 28 cm) A4
Media size	4 x 6 inch (10 x 15 cm) 8 x 10 inch, US Letter (8.5 x 11 inch) A4 (21 x 30 cm)
Auto-detect media	Auto-detect plain paper, photo paper, and transparency Optimize image quality for Kodak Photo Papers with custom watermark
Image enhancement	Kodak Perfect Touch Technology

Copying features	
Copy color	Black & white or color
Copy quantity	1 to 9 copies
Copy size functions	100% and fit-to-page

Scanning features	
Scanner type	Contact Image Sensor (CIS) type scanner
Maximum scan size	8.5 x 11.7 in. (21.6 x 29.7 cm)

Paper tray	
Paper capacity:	Main: 100 sheets of 20 lb plain paper; 30 sheets of 10 mil photo paper
Tray capacity	4 x 6 in. to 8.5 x 14 in. (10 x 15 cm to 21.6 x 36 cm)

Ink tanks	
Ink handling	2-cartridge, 6-ink system
Ink life	1-year warranty from date of purchase.

Connectivity	
Protocols supported	USB 2.0 (Mass Storage & PTP), USB PTP, BLUETOOTH® 2.0, PictBridge, DPOF, MIPC
Devices supported	Windows and Macintosh computers, USB mass storage devices, memory cards (MS, XD, SD, and CF), PictBridge-enabled digital still cameras, and BLUETOOTH® Technology-enabled imaging devices
Image formats supported	JPEG (EXIF V2.2) (progressive JPEG format not supported) AVI and WAV (transfer only)
Number of USB ports	One front host port (full speed), one rear device port (high speed)

Software support	
Application support	Third-party image management applications or Kodak EasyShare Software for pictures; optical character reader (OCR) support for documents
Media support	Plain paper, photo paper, envelopes, greeting cards, transparencies, labels, t-shirt transfers
Scanner support	TWAIN and WIA import, including EasyShare Software, segmentation scanning
File transfer support	Automatic color, contrast, sharpness improvements upon transfer to PC
Update support	Software and firmware updates available through web support

Physical specifications	
Power	US: 110–120 V AC, 60 Hz WW: 110–240 V AC, 50–60 Hz Output: 36 V AC at 3 A (65 watt)
Dimensions	16.6 x 7.0 x 11.8 in (422 x 178 x 299 mm) [W x H x D]
Weight	13.1 lbs (5.9 kg)
Operating range	5°C (41°F) to 35°C (95°F), 15 to 85 % RH (non-condensing), and atmospheric pressure up to 10,000 ft ASL)
Full IQ environmental range	15°C (59°F) to 30°C (86°F), and 20 to 80 % RH

Warranty	
Product	One year from purchase (with proof of purchase).
Printhead	One year from purchase (with proof of purchase).
Ink Cartridges	13 months from date of manufacture or until "replace cartridge" message, whichever comes first.

System Requirements

The following specifications are subject to change without notice.

Windows PC	Minimum	Recommended
Operating System	Microsoft Windows XP SP2	Microsoft Windows XP 64, Vista
CPU	Celeron	32 or 64 Bit
Clock Speed	1.2 GHz	2 GHz
Memory	512 MB RAM	1024 MB RAM
Available Disk Space	200 MB	40 GB with 1 GB free
Interface	USB 2.0	USB 2.0
Removable Drive	CD-ROM	CD-ROM
Other	Internet access	Internet access

Macintosh	Minimum	Recommended
Operating System	Macintosh OS X 10.4.8	10.5 or greater
Computer	Powermac or Powerbook G3, G4; iMac; eMac; or iBook	Intel Mac
Clock Speed	800 MHz	2 GHz
Memory	512 MB RAM	1024 MB RAM
Available Disk Space	200 MB	200 MB
Interface	USB 1.0	USB 2.0
Removable Drive	CD-ROM	CD-ROM
Other	Internet access	Internet access

Paper Supported

The following tables show the paper types and sizes supported by the Kodak printer.

Paper Types Supported	
Plain paper	20 to 24 lb (60 to 90 gsm)
Photo paper	5 to 10 mils
Card stock	110 lb index max (200 gsm)
Envelopes	20 to 24 lb (75 to 90 gsm)
Transparencies	All commercially available inkjet varieties (with or without a white stripe.)
Labels	All commercially available inkjet varieties on 8.5 x 11 and A4 size sheets
Iron-on transfers	All commercially available inkjet varieties on 8.5 x 11 and A4 size sheets

Paper Sizes Supported	
Usage	Size
Plain paper	A4 (210 x 297 mm) A5 (148 x 210 mm) A6 (105 x 148 mm) B5 (176 x 250 mm) US Executive (7.25 x 10.5 in.) (184 x 266 mm) US Letter (8.5 x 11 in.) (216 x 280 mm) US Legal (8.5 x 14 in.) (216 x 356 mm) Custom sizes (3.8 to 8.5 in.) (92–216 mm) wide, (5 to 14 in.) (127–356 mm) long
Plain paper labels	US Letter (8.5 x 11 in.) (216 x 280 mm) A4 (210 x 297 mm)
Index card stock	4 x 6 in. index cards (101 x 152 mm) 5 x 7 in. index cards (127 x 178 mm)
Transparency and labels Iron-on transfers	A4 (210 x 297 mm) US Letter (8.5 x 11 in.) (216 x 280 mm)
Envelopes	C5 (6.38 x 9 in.) (162 x 299 mm) C6 (4.49 x 6.38 in.) (114 x 162 mm) A2 (4.37 x 5.75 in.) (111 x 146 mm) DL (designated long) (4.33 x 8.66 in.) (110 x 220 mm) US #9 (3.8 x 8.8 in.) (98 x 225 mm) US #10 (4.12 x 9.5 in.) (105 x 241 mm)
Photo	4 x 6 in. (102 x 152 mm) 4 x 12 in. (102 x 305 mm) 5 x 7 in. (127 x 178 mm) (called "2L" in Japan) 8 x 10 in. (203 x 254 mm) US Letter (8.5 x 11 in.) (216 x 280 mm) A4 (210 x 297 mm)

Safety

- Read and follow these cautions and warnings before using Kodak products.
- Always follow basic safety procedures.
- Follow all warnings and instructions marked on the Kodak ESP 3 All-in-One printer.

Parts



Caution Do not disassemble this product; there are no user-serviceable part(s) inside. Refer servicing to Kodak qualified service personnel.



Warning Keep out of reach of children. Ink may be harmful if swallowed.

Power



Caution If the power cord or plug is frayed or damaged, the equipment gets wet, or the equipment does not operate normally when the operating instructions are followed, unplug your printer from the power outlet and refer servicing to qualified service personnel.



Caution The AC adapter power supply is equipped with a three-wire grounding type plug. If you cannot insert the plug into the power outlet, contact an electrician to check or replace the power outlet.



Caution Do not plug the AC adapter into a household extension cord.



Caution For added protection from damage during a lightning storm, or any time when your printer and its associated AC adapter will be left unused for long periods of time, unplug the AC adapter from the power outlet.



Warning Pushing objects through the equipment openings can result in an electric shock or risk of fire.



Warning The use of an accessory attachment that is not recommended by Kodak, such as an AC adapter, could cause fire, electric shock, or injury.

Location



Caution To prevent your printer from overheating do not block or cover the slots and openings in the equipment, place it near a heat register, or install it in a cabinet without proper ventilation.



Caution Do not use your printer near water, or spill liquid on it.



Warning Do not place your printer on an unstable cart, stand, bracket, or table. Injury to persons and damage to the equipment may occur.

Environment



Caution Excessive dust levels may damage internal parts.



Caution Unplug the equipment from the wall outlet before cleaning.



Caution Dropping your printer may damage the housing and result in extensive damage that will require repair by a qualified technician to restore normal operation.



Warning Do not expose this product to liquid, moisture, or extreme temperatures. KODAK AC adapters are intended for indoor use only. The use of controls, adjustments, or procedures other than those specified herein may result in exposure

to shock and/or electrical or mechanical hazards.



Caution Adjust only those controls covered in the operating instructions.

For more information, go to www.Kodak.com/go/MSDS.

Regulatory Compliance



FCC Compliance and Advisory

This equipment has been tested and found to comply with the limits for a Class B digital device, pursuant to Part 15 of the FCC Rules. These limits are designed to provide reasonable protection against harmful interference in a residential installation.

This equipment generates, uses, and can radiate radio frequency energy and, if not installed or used in accordance with the instructions, may cause harmful interference to radio communications. However, there is no guarantee that interference will not occur in a particular installation.

If this equipment does cause harmful interference to radio or television reception, which can be determined by turning the equipment off and on, you are encouraged to try to correct the interference by one or more of the following measures: 1) reorient or relocate the receiving antenna; 2) increase the separation between the equipment and the receiver; 3) connect the equipment to an outlet on a circuit different from that to which the receiver is connected; 4) consult the dealer or an experienced radio/TV technician for additional suggestions.

Any changes or modifications not expressly approved by the party responsible for compliance could void the user's authority to operate the equipment. Where shielded interface cables have been provided with the product or specified additional components or accessories elsewhere defined to be used with the installation of the product, they must be used in order to ensure compliance with FCC regulation.



Caution When using the Bluetooth interface with a Kodak printer, the transmitter must not be collocated or operate in conjunction with any other antenna or transmitter.

FCC and Industry Canada

This device complies with Industry Canada RSS-210 and FCC Rules. Operation is subject to the following two conditions: (1) this device may not cause harmful interference, and (2) this device must accept any interference received, including interference that may cause undesired operation.

Canadian DOC Statement

DOC Class B Compliance—This Class B digital apparatus complies with Canadian ICES-003.

Observation des normes-Class B—Cet appareil numérique de la classe B est conforme à la norme NMB-003 du Canada.

German Compliance Statement

Noise emissions for this equipment do not exceed 70 dBA.

This equipment is not intended for use in the work place in accordance with BildscharbV regulations.

"Das Gerät ist nicht für die Benutzung am Bildschirmarbeitsplatz gemäß BildscharbV vorgesehen."



Caution There is risk of explosion if the battery is replaced by an incorrect type. Dispose of used batteries according to the instructions. Contact your local Kodak representative or refer to www.kodak.com/go/recycle for additional information on the collection and recovery programs for batteries.

Achtung Explosionsrisiko wenn die Batterie durch einen inkorrekten Typen ersetzt wird. Entsorgung der Batterie gemäss der Gebrauchsanweisung. Bitte kontaktieren Sie Ihren lokalen Kodak Repräsentanten oder www.kodak.com/go/recycle für mehr Informationen über das Sammeln und Wiederverwerten von Batterien.

Waste Electrical and Electronic Equipment labeling



In the European Union, this symbol indicates that when the last user wishes to discard this product, it must be sent to appropriate facilities for recovery and recycling. Contact your local Kodak representative or refer to www.kodak.com/go/recycle for additional information on the collection and recovery programs available for this product.

Glossary

A

ADF: Automatic Document Feeder

D

dongle: A small electronic device that plugs into a USB port.

dpi: dots per inch

DPOF: Digital Print Order File. This file allows the user of a digital camera to define which captured images on the storage card are to be printed, together with information on the number of copies or other image information such as paper size, image title text, image orientation, contact information and more.

E

EXIF: Exchangeable Image File Format. A standard for storing interchange information in image files, especially those using JPEG compression. Most digital cameras now use the EXIF format.

G

Grayscale: A grayscale digital image is an image in which the value of each pixel is a single sample. Displayed images of this sort are typically composed of shades of gray, varying from black at the weakest intensity to white at the strongest. Grayscale images are distinct from black-and-white images, which are images with only two colors, black and white; grayscale images have many shades of gray in between.

J

JPEG: Joint Photographic Experts Group. The name of the committee that developed the image file format. JPEG is a compressed image file format. JPEG is a "lossy" format, which means some quality is lost when the image is compressed.

K

Kodak Perfect Touch: Automatically corrects for common image flaws and "mistakes," such as shadows, and backlighting. Kodak Perfect Touch technology also enhances the desirable qualities of pictures, for vibrant color and richer detail. This feature is available when scanning or copying pictures. Color restoration and Kodak Perfect Touch can be used together to enhance pictures. This feature is not available when scanning black and white pictures.

KPT: Kodak Perfect Touch.

O

OCR: Optical character recognition.

P

PictBridge: PictBridge is a Camera and Imaging Products Association standardized technology that allows printing of images between any PictBridge compliant digital camera and any PictBridge compliant printer. Thus, you can print from a memory card in a digital camera directly to a printer, regardless of brand. No computer is necessary. Each device is automatically recognized by the other. The camera compares its PictBridge functions to the functions of the printer. The camera then displays the supported functions on menus on the LCD screen or in the viewfinder. Once a PictBridge digital camera is connected to a compliant printer, print options appear on the camera monitor (LCD). The camera menu system is used to select settings such as print size, layout, media type, and date. You can print a single image displayed on the camera, print two or more images, or print all of the images on the memory card. You can print part of an image by first cropping it within the camera and even create index prints (contact sheets). To find out if a camera or printer is PictBridge compatible, look for the PictBridge logo on the packaging or check the manual for specifications.

PTP: Picture Transfer Protocol. A standard for transferring pictures from a digital camera.

R

red eye: The red-eye effect in flash photography is caused by the light from the flash reflecting off the blood vessels and interior eye tissue in humans. Animal eye glow from reflections is caused by a different internal eye structure, which is much like a mirror. When not enough time elapses between the flash and exposure (as with most compact cameras), the light of the flash occurs too fast for the iris of the eye to close the pupil. The flash of light is focused by the lens of the eye onto the blood-rich retina at the back of the eye. The image of the illuminated retina is then focused by the lens of the eye back to the camera, resulting in a red appearance of the eye on the picture.

Glossary

B

borderless..... 52

C

camera44

Clean Printhead 37

cleaning.....34

communication.....46

components..... 4

computer46

control panel.....2

copy problems 52

copy troubleshooting52

cropped pictures49

customer support.....41, 42

D

dark print51

demo page11

diagnostic page.....34

E

envelopes16

F

FCC compliance60

G

glass.....34

H

Home Center8, 9

I

ink cartridge.....34, 35, 44

ink levels35

J

jammed paper47

L

Letter Paper24

light print51

loading paper.....13

M

maintenance 33

memory cards1, 44

O

Originals.....13

P

paper 13, 48

paper feed 45, 46

paper jam.....47

paper tray 14

Photo Layout.....21, 22, 23

photo paper.....15

PictBridge 49

power.....43

print problems..... 48, 49, 50, 52

print quality.....50

print smudged50

print spotted51

print troubleshooting..... 48

printer not responding47

printhead36, 38

Printhead Alignment.....37

printing.....18

R

regulatory compliance 60

S

safety59

scan problems53

scanner lid34

slow printing51

status monitor11

support 41, 42

T

technical support..... 41, 42

transfer 17, 48

U

USB Port..... 5, 44

W

waste labeling..... 60

white edges..... 52



1K3254

Rev E
