

See your extended user's guide – for more information about using your frame, visit www.kodak.com/go/digitalframesupport.

Remote control

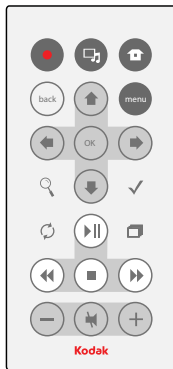

* First, turn on the power switch on the frame.

† Remove tab to activate the remote.



Button	Press to
	power* turn on/off the picture frame.
	home return to the home screen.
	pics/music toggle between viewing pictures and selecting music.
menu	menu display menu choices.
back	back return to the previous screen. stop a slide show, display thumbnails.
OK	OK accept the current selection.
	4-way navigate through pictures or menus.
	zoom magnify the picture.
	rotate rotate the picture, 90° clockwise each press.
	select mark pictures for an operation.
	slide show play a slide show.
	play/pause play/pause a video or slide show.
	rewind rewind a video.
	fast forward fast forward a video.
	stop stop a video, display the first frame. stop a slide show, display thumbnails.
-/+	volume decrease (-) or increase (+) the volume.
	mute mute audio.

Front View

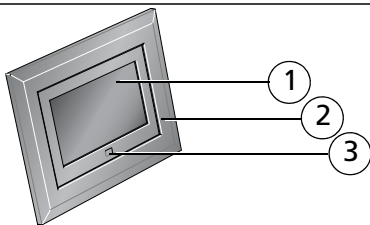

- 1 LCD screen
- 2 Faceplate
- 3 Remote control sensor

Back/Left Side View

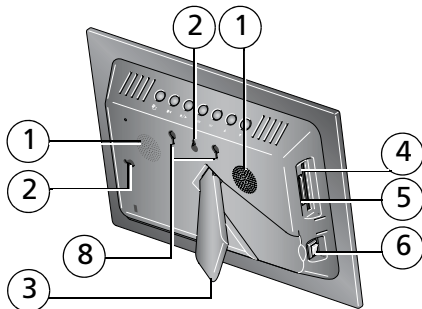

- 1 Speakers
- 2 Wall mount hangers
- 3 Frame stand
- 4 Memory card slot - CF, MD

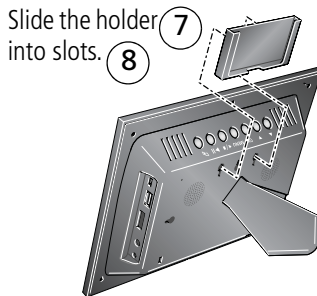



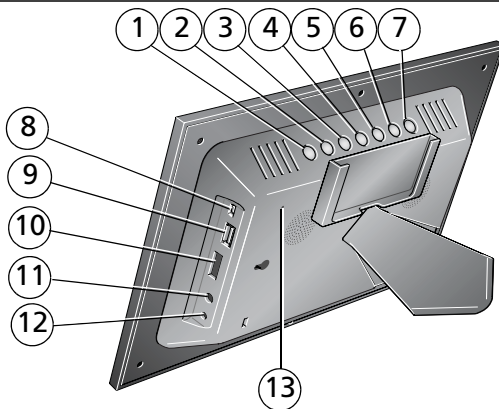

Slide the holder (7)
into slots. (8)

- 5 Memory card slot - SD, MS, xD, MMC
- 6 On/Off switch
- 7 Remote control holder (removable)
- 8 Slots for remote control holder

Top/Right Side View



- | | | | |
|---|--|----|--|
| 1 | Picture/music toggle  | 8 | USB connector (connect to computer) |
| 2 | Play/Pause  | 9 | USB connector (connect to camera/USB device) |
| 3 | Stop/Back  | 10 | Volume control |
| 4 | Menu | 11 | Headphone jack  |
| 5 | OK | 12 | DC-In (12 V)  |
| 6 | Down ▼ | 13 | Reset button |
| 7 | Up ▲ | | |

1 Installing the software

Insert the EasyShare software CD



CD packaged with your frame.



- Install or upgrade to this special version of EasyShare software to easily copy pictures and videos from your computer to your frame.

2 Connecting the power cable

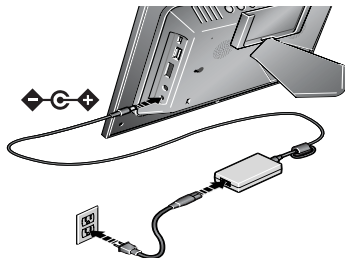

Your power cable (included with the frame) may be different from the one pictured. Use the plug that accommodates your type of power outlet.

3 Turning on the frame

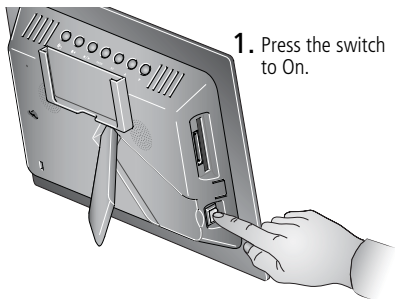

1. Press the switch to On.

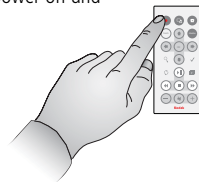

2. Then use the remote control to turn the power off and on.



4 Setting your language

The language setup screen appears the first time you turn on the frame.



1.  /  to change.

2. OK to accept.

A slide show starts from sample pictures pre-loaded in internal memory (not available on the SV710 frame).





5 Viewing your first pictures

To play a slide show, insert a memory card or USB device (see step **6** on the next page).



If a slide show is already playing (for example, from the pre-loaded sample pictures*), your slide show starts automatically.

If you are at the Home screen, press ◀ ▶ on the remote control to highlight your picture source, then press  to start the slide show.

 — To play music with your pictures or slide shows, see [page 10](#).

* Not available on the SV710 frame.

6 Inserting memory card/USB device

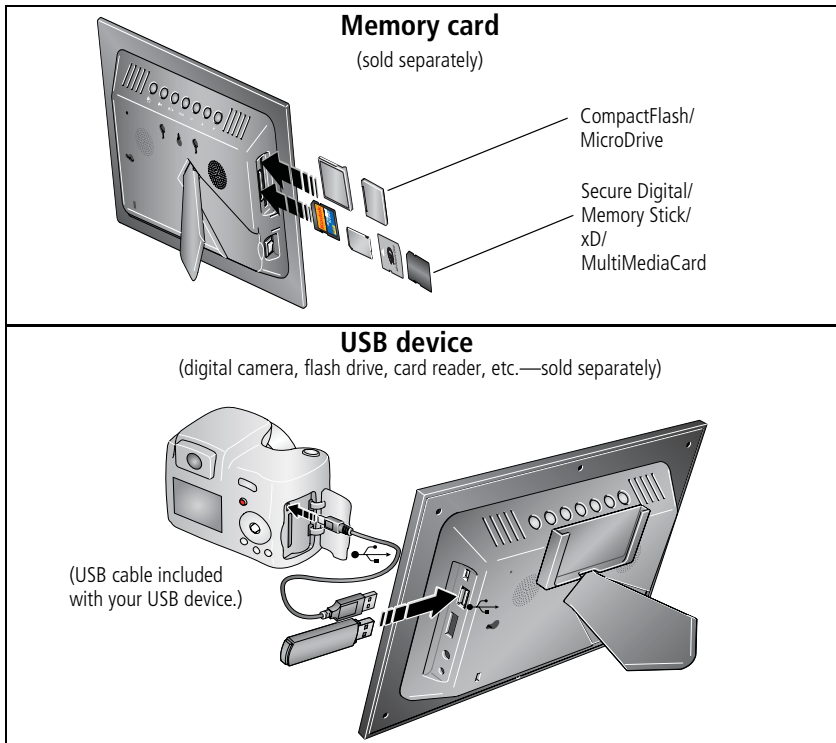

1 Doing more

All buttons and controls described are on the remote control unless otherwise specified.

Home screen—picture sources and settings



- 1 Press .

All connected sources and the Settings icon are displayed.

- 2 Press   to highlight a picture source, then:

- Press  to start a slide show.
- Or, press OK to display thumbnails and folders.

Home screen options:



My Frame—the frame's 128 Mb internal memory (unavailable on the SV710 frame). Copy your pictures into My Frame from a memory card or other device ([page 11](#)).



Memory card—appears when you insert a card ([page 7](#)). The label and icon indicate the type of card.



Camera—appears when you connect a digital camera via USB cable ([page 7](#)).



USB drive—appears when you insert a USB flash drive ([page 7](#)).



Settings—customize your frame settings. For example; set slide show durations and transitions, set viewing options, screen brightness, clock, and timer. See the extended user's guide at www.kodak.com/go/digitalframesupport.

Viewing pictures and videos

For supported picture, video, and music file formats, see the extended user's guide.

Running a slide show



There are three ways to start a slide show:

- Insert a memory card or connect a USB device, then turn on the frame.
- Turn on the frame, then insert a card or connect a USB device – a new slide show starts automatically, replacing a currently running slide show or single view picture.
- Select a picture in thumbnail view or select a picture source on the Home screen, then press ►|| or .



Viewing thumbnails







There are two ways to view your pictures as thumbnails:

- Press , select a picture source (see [page 8](#)), then press OK.
- Press  or back from a slide show or single view.

Other things to do in thumbnails view:



- To navigate through the thumbnails, press .
- To play a video () , highlight it and press OK.
- To view the pictures in a different folder, highlight it and press OK.

Single view

- To view a single, full-screen picture, highlight it in thumbnails view and press OK.
- To magnify a picture up to 8X, press . To view other parts of the picture, press . Continue pressing  to return to full view.
- To rotate a picture, press .

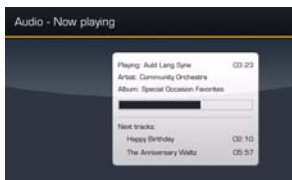
Playing music





- 1 Press  to pause your picture or slide show and display the Audio screen.
- 2 Press  to highlight a music source, then press OK.
- 3 Press  to go to the next or previous song, or select Play all songs. Then press OK.

Your music starts playing.

- 4 Press  to return to your picture or slide show.

Your selected music continues to play as the slide show resumes. When music is playing, videos play without their related audio (default setting).

- 5 To turn off music, press , then .

- 6 Press  again to return to your pictures.

NOTE: To copy audio files to internal memory, drag and drop them from your computer via the included USB cable. See your extended user's guide.

Deleting pictures



- 1 Press to highlight a picture/video, then press .
- 2 Press to highlight Delete, then press OK.
- 3 Highlight Delete and press OK again to confirm. To cancel the deletion, highlight Exit, then press OK. *The picture/video is deleted.*

To delete multiple pictures/videos, see [page 12](#).

NOTE: You can delete pictures/videos from a card, internal memory, or some connected USB devices.

Copying pictures

Copy pictures/videos from your current viewing location to internal memory (not available on SV710), or other connected devices.

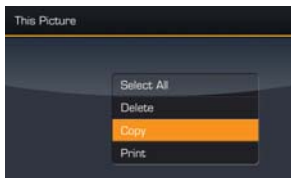

- 1 Display a picture in single view, then press .
- 2 Press to highlight Copy, then press OK.
- 3 Press to highlight the location you want to copy to, then press OK.



To copy multiple pictures/videos, see [page 12](#).

To copy pictures and videos to/from your computer, see the extended user's guide.

Selecting multiple pictures

Use the multi-select feature to copy or delete two or more pictures/videos; or to play a slide show of selected pictures/videos.

Selecting one at a time

- 1 In thumbnails view, press  to highlight a picture/video, then press .
- 2 Continue selecting pictures/videos.

A check mark appears on the selected pictures. Press  again to remove a check mark. You can now view a slide show, and copy, print, delete, etc. all selected pictures.

Selecting all at once

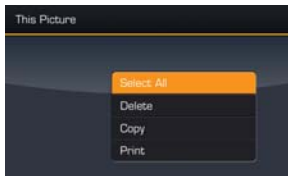

- 1 Press  whenever pictures/videos are displayed (slide show, video, single picture).

- 2 Press  to highlight Select All, then press OK.

A confirmation screen appears, then your picture display reappears. A check mark appears on all pictures/videos in your current location.

- 3 To remove the check marks, press , then Select/Unselect All → OK → Unselect All → OK.

Printing pictures

For printing to a PictBridge enabled printer, see the extended user's guide.

Learning more about your frame

www.kodak.com/go/digitalframes	Frame accessories, including fashion faceplates
www.kodak.com/go/digitalframesupport	Extended user's guide
	Interactive troubleshooting and repairs
	Interactive tutorials
	FAQs
	Downloads
	Product registration

For package contents, see your product package.

Important safety instructions



CAUTION:

Do not disassemble this product; there are no user-serviceable parts inside. Refer servicing to qualified service personnel. Do not expose this product to liquid, moisture, or extreme temperatures. The use of controls, adjustments, or procedures other than those specified herein may result in exposure to shock and/or electrical or mechanical hazards. If the LCD breaks, do not touch the glass or liquid. Contact Kodak customer support.

- The use of an accessory that is not recommended by Kodak may cause fire, electric shock, or injury. For approved accessories, visit www.kodak/go/accessories.
- Use only a USB-certified computer equipped with a current-limiting motherboard. Contact your computer manufacturer if you have questions.
- When removing the battery from the remote, allow it to cool; it may be hot.
- Follow all warnings and instructions supplied by the battery manufacturer.
- Use only batteries approved for this product to avoid risk of explosion.
- Keep batteries out of the reach of children.
- Do not allow batteries to touch metal objects, including coins. Otherwise, a battery may short circuit, discharge energy, become hot, or leak.
- Do not disassemble, install backward, or expose batteries to liquid, moisture, fire, or extreme temperature.
- Remove the battery when the product is stored for an extended period of time. In the unlikely event that battery fluid leaks inside the product, contact Kodak customer support.
- In the unlikely event that battery fluid leaks onto your skin, wash immediately with water and contact your local health provider. For additional health-related information, contact your local Kodak customer support.
- Dispose of batteries according to local and national regulations. Visit www.kodak.com/go/kes.
- Do not charge non-rechargeable batteries.

For more information on batteries, visit www.kodak.com/go/batterytypes.

- Digital picture frame battery (internal and non-removable) and remote control battery may include perchlorate material. Special handling may apply in California.
- Read and follow all warnings and instructions supplied by the battery manufacturer.

Upgrading your software and firmware

Download the latest versions of the software and the frame firmware (the software that runs on the frame). See www.kodak.com/go/digitalframedownloads.

Additional care and maintenance

- Wipe the frame and the LCD gently with a soft, lint-free cloth or an untreated lens-cleaning tissue. Do not use cleaning solutions unless designed specifically for LCD screens. Do not allow chemicals, such as suntan lotion, to contact painted surfaces.
- Service agreements are available in some countries. Contact a dealer of Kodak products for more information.
- For digital frame disposal or recycling information, contact your local authorities. In the US, visit the Electronics Industry Alliance Web site at www.eiae.org or visit www.kodak.com/go/digitalframesupport.

Limited warranty

Kodak warrants Kodak consumer electronic products and accessories ("Products"), excluding batteries, to be free from malfunctions and defects in both materials and workmanship for one year from the date of purchase. Retain the original dated sales receipt. Proof of the date of purchase will be required with any request for warranty repair.

Limited warranty coverage

Warranty service is only available from within the country where the Products were originally purchased. You may be required to ship Products, at your expense, to the authorized service facility for the country where the Products were purchased. Kodak will repair or replace Products if they fail to function properly during the warranty period, subject to any conditions and/or limitations stated herein. Warranty service will include all labor as well as any necessary adjustments and/or replacement parts. If Kodak is unable to repair or replace a Product, Kodak will, at its option, refund the purchase price paid for the Product provided the Product has been returned to Kodak along with proof of the purchase price paid. Repair, replacement, or refund of the purchase price are the sole remedies under the warranty. If replacement parts are used in making repairs, those parts may

be remanufactured, or may contain remanufactured materials. If it is necessary to replace the entire Product, it may be replaced with a remanufactured Product. Remanufactured Products, parts and materials are warranted for the remaining warranty term of the original Product, or 90 days after the date of repair or replacement, whichever is longer.

Limitations

This warranty does not cover circumstances beyond Kodak's control. This warranty does not apply when failure is due to shipping damage, accident, alteration, modification, unauthorized service, misuse, abuse, use with incompatible accessories or attachments (such as third party ink or ink tanks), failure to follow Kodak's operation, maintenance or repacking instructions, failure to use items supplied by Kodak (such as adapters and cables), or claims made after the duration of this warranty. Kodak makes no other express or implied warranty for this product, and disclaims the implied warranties of merchantability and fitness for a particular purpose. In the event that the exclusion of any implied warranty is ineffective under the law, the duration of the implied warranty will be one year from the purchase date or such longer period as required by law. The option of repair, replacement, or refund is Kodak's only obligation. Kodak will not be responsible for any special, consequential or incidental damages resulting from the sale, purchase, or use of this product regardless of the cause. Liability for any special, consequential or incidental damages (including but not limited to loss of revenue or profit, downtime costs, loss of the use of the equipment, cost of substitute equipment, facilities or services, or claims of your customers for such damages resulting from the purchase use or failure of the Product), regardless of cause or for breach of any written or implied warranty is expressly disclaimed.

Your rights

Some states or jurisdictions do not allow exclusion or limitation of incidental or consequential damages, so the above limitation or exclusion may not apply to you. Some states or jurisdictions do not allow limitations on how long an implied warranty lasts, so the above limitation may not apply to you. This warranty gives you specific rights, and you may have other rights which vary from state to state or by jurisdiction.

Outside the United States and Canada

In countries other than the United States and Canada, the terms and conditions of this warranty may be different. Unless a specific Kodak warranty is communicated to the purchaser in writing by a Kodak company, no warranty or liability exists beyond any minimum requirements imposed by law, even though defect, damage, or loss may be by negligence or other act.

FCC compliance and advisory



Kodak EasyShare digital picture frame

This equipment has been tested and found to comply with the limits for a Class B digital device, pursuant to Part 15 of the FCC Rules. These limits are designed to provide reasonable protection against harmful interference in a residential installation.

This equipment generates, uses, and can radiate radio frequency energy and, if not installed or used in accordance with the instructions, may cause harmful interference to radio communications. However, there is no guarantee that interference will not occur in a particular installation.

If this equipment does cause harmful interference to radio or television reception, which can be determined by turning the equipment off and on, the user is encouraged to try to correct the interference by one or more of the following measures: 1) reorient or relocate the receiving antenna; 2) increase the separation between the equipment and the receiver; 3) connect the equipment to an outlet on a circuit different from that to which the receiver is connected; 4) consult the dealer or an experienced radio/TV technician for additional suggestions.

Any changes or modifications not expressly approved by the party responsible for compliance could void the user's authority to operate the equipment. Where shielded interface cables have been provided with the product or specified additional components or accessories elsewhere defined to be used with the installation of the product, they must be used in order to ensure compliance with FCC regulation.

FCC and Industry Canada

This device complies with Industry Canada RSS-210 and FCC Rules. Operation is subject to the following two conditions: (1) this device may not cause harmful interference, and (2) this device must accept any interference received, including interference that may cause undesired operation.

FCC et Industrie Canada

Cet appareil est conforme à la norme RSS-210 d'Industrie Canada et aux réglementations de la FCC. Son utilisation est soumise aux deux conditions suivantes : (1) cet appareil ne doit pas provoquer d'interférences nuisibles, et (2) cet appareil doit supporter les interférences reçues, y compris celles susceptibles de nuire à son bon fonctionnement.

CE

Hereby, Eastman Kodak Company declares that this Kodak product is in compliance with the essential requirements and other relevant provisions of Directive 1999/5/EC.

This digital picture frame EX811 and EX1011 transmits in 10 dBm. In France, the power level is limited to 10dBm in outdoor environments, per regulations. When in France, use the wireless functions of this device indoors only.

Canadian DOC statement

DOC Class B Compliance—This Class B digital apparatus complies with Canadian ICES-003.

Observation des normes-Classe B—Cet appareil numérique de la classe B est conforme à la norme NMB-003 du Canada.

Waste Electrical and Electronic Equipment labeling



EU: It is the final user's responsibility to discard this equipment into an approved, segregated collection scheme to enable its suitable treatment/disposal and to improve human/environmental protection. For more information, see your retailer, local authority, or www.kodak.com/go/recycle.

Australian C-Tick



N137

MPEG-4

Use of this product in any manner that complies with the MPEG-4 visual standard is prohibited, except for use by a consumer engaging in personal and non-commercial activities.

Korean Class B ITE

이 기기는 가정용으로 전자파적합등록을 한 기기로서 주거지역에서는 물론 모든 지역에서 사용할 수 있습니다.

China RoHS

环保使用期限 (EPUP)

在中国大陆，该值表示产品中存在的任何危险物质不得释放，以免危及人身健康、财产或环境的时间期限（以年计）。该值根据操作说明中所规定的产品正常使用而定。

Environmental Protection Use Period (EPUP)

In China, this number indicates the time period (in years) within which any hazardous substances present in the product are not expected to be released such that there is risk to human health, property, or the environment. This value is assigned based on normal use of the product as described in the operating instructions.

Product Disclosure Table

有毒有害物质或元素名称及含量标识表
table of hazardous substances' name and concentration

部件名称 Component name	有毒有害物质或元素 hazardous substances' name					
	铅 (Pb)	汞 (Hg)	镉 (Cd)	六价铬 (Cr6+)	多溴联苯 (PBB)	多溴二苯 醚 (PBDE)
数码相架电路板元件 (Digital Photo Frame circuit board components)	X	O	O	O	O	O
控制器 (Controller)	X	O	O	O	O	O
交流变压器电路板元件 (AC Adapter circuit board components)	X	O	O	O	O	O

○：表示该有毒有害物质在该部件所有均质材料中的含量均在SJ/T 11363-2006规定的限量要求以下。
 ×：表示该有毒有害物质至少在该部件的某一均质材料中的含量超出SJ/T 11363-2006规定的限量要求。
 ○：indicates hazardous substance concentration lower than MCV
 ×：indicates hazardous substance concentration higher than MCV



USB 数据线

Russian GOST-R



Eastman Kodak Company
Rochester, New York 14650

Цифровая фоторамка изготовлена в Китае; остальные элементы –
в соответствии с маркировкой

Licensing

Supply of this product does not convey a license nor imply any right to distribute content created with this product in revenue-generating broadcast systems (terrestrial, satellite, cable and/or other distribution channels), streaming applications (via Internet, intranets and/or other networks), other content distribution systems (pay-audio or audio-on-demand applications and the like) or on physical media (compact discs, digital versatile discs, semiconductor chips, hard drives, memory cards and the like). An independent license for such use is required. For details, please visit <http://mp3licensing.com>.

Kodak

Eastman Kodak Company

Rochester, New York 14650

© Eastman Kodak Company, 2007

Kodak and EasyShare are trademarks of Eastman Kodak Company.

Eastman Kodak Company is an authorized licensee of the CompactFlash trademark.

2F6838_en