

---

# Kodak EasyShare C663 zoom digital camera



## User's guide

[www.kodak.com](http://www.kodak.com)

For interactive tutorials, [www.kodak.com/go/howto](http://www.kodak.com/go/howto)

For help with your camera, [www.kodak.com/go/C663support](http://www.kodak.com/go/C663support)



Eastman Kodak Company  
Rochester, New York 14650

© Eastman Kodak Company, 2005

All screen images are simulated.

Kodak, EasyShare, and Perfect Touch are trademarks of Eastman Kodak Company.  
Schneider-Kreuznach and Xenar are trademarks of Jos. Schneider Optische Werke  
GmbH used under license by Eastman Kodak Company.

P/N 4J4304\_en

## Front view

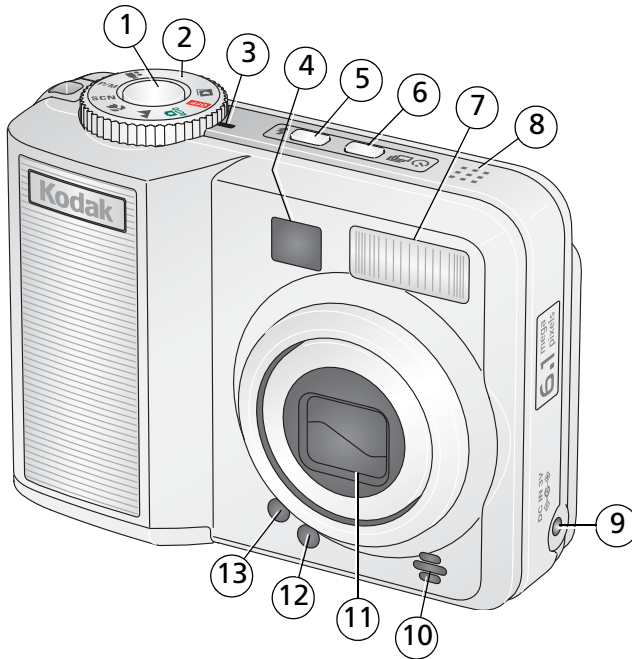

- |   |                         |    |                                                                                                                               |
|---|-------------------------|----|-------------------------------------------------------------------------------------------------------------------------------|
| 1 | Shutter button          | 8  | Speaker                                                                                                                       |
| 2 | Mode dial               | 9  | DC-In (3V)  , for <b>optional</b> AC adapter |
| 3 | Power light             | 10 | Microphone                                                                                                                    |
| 4 | Viewfinder              | 11 | Lens                                                                                                                          |
| 5 | Flash button            | 12 | Light sensor                                                                                                                  |
| 6 | Self-timer/Burst button | 13 | Self-timer light                                                                                                              |
| 7 | Flash                   |    |                                                                                                                               |

## Back view

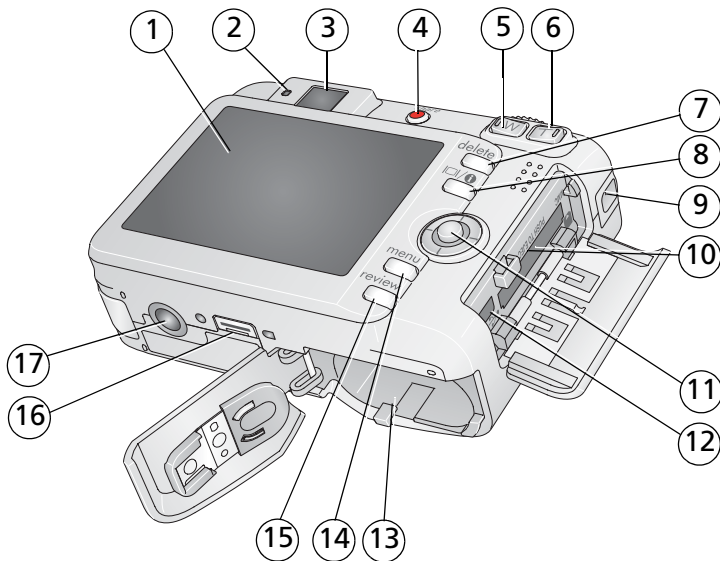

- |                     |                                                                                                                    |
|---------------------|--------------------------------------------------------------------------------------------------------------------|
| 1 LCD               | 10 Slot for optional SD or MMC card                                                                                |
| 2 Ready light       | 11 Joystick (  , press in for OK) |
| 3 Viewfinder        | 12 USB, A/V Out                                                                                                    |
| 4 Share button      | 13 Battery compartment                                                                                             |
| 5 Wide angle button | 14 Menu button                                                                                                     |
| 6 Telephoto button  | 15 Review button                                                                                                   |
| 7 Delete button     | 16 Dock connector                                                                                                  |
| 8 LCD/Info button   | 17 Tripod socket                                                                                                   |
| 9 Strap post        |                                                                                                                    |

---

# Table of contents

<b>1</b>	<b>Setting up your camera</b>	<b>1</b>
	Installing the software	1
	Attaching the strap	1
	Loading the battery	2
	Turning on the camera	3
	Setting the language, date/time	4
	Storing pictures on an SD or MMC card	5
<b>2</b>	<b>Taking pictures and videos</b>	<b>6</b>
	Taking a picture	6
	Reviewing pictures and videos on your camera	10
<b>3</b>	<b>Transferring and printing pictures</b>	<b>13</b>
	Installing the software	13
	Transferring pictures	14
	Printing pictures	15
	Dock compatibility for your camera	18
<b>4</b>	<b>Doing more with your camera</b>	<b>19</b>
	Using optical zoom	19
	Changing the flash settings	20
	Picture-taking modes	21
	Using exposure compensation to adjust brightness	23
	Using the histogram to view picture brightness	23
	Using P/M modes	24
	Using the self-timer	26
	Using burst	27
	Changing picture-taking settings	28
	Customizing your camera	31
	Running a slide show	34
	Using Kodak Perfect Touch technology	35
	Cropping pictures	36

Making a video action print.....	36
Viewing picture/video information .....	37
Copying pictures and videos.....	37
Pre-tagging for album names .....	38
Tagging pictures/videos for albums.....	39
Sharing your pictures.....	40
<b>5 Troubleshooting .....</b>	<b>44</b>
Camera problems.....	44
Computer/connectivity problems.....	46
Picture quality problems .....	46
Direct printing (PictBridge enabled printer) problems.....	48
<b>6 Getting help .....</b>	<b>49</b>
Helpful links.....	49
Telephone customer support .....	50
<b>7 Appendix .....</b>	<b>51</b>
Camera specifications .....	51
Storage capacities.....	55
Important safety instructions .....	56
Battery life .....	57
Upgrading your software and firmware.....	58
Additional care and maintenance .....	58
Warranty.....	59
Regulatory compliance .....	61

# 1

## Setting up your camera

### Installing the software

**IMPORTANT:** Before connecting any cables, install the software that was included with your camera. For details, see [Transferring and printing pictures, page 13](#).

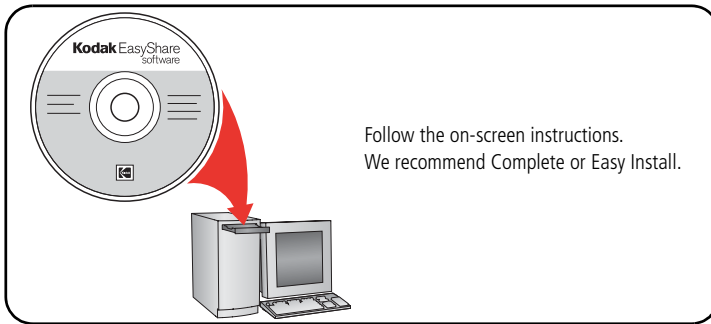

### Attaching the strap

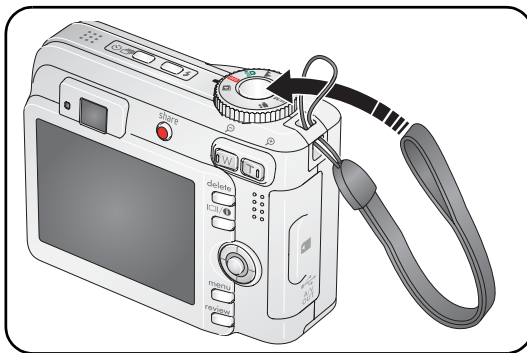

## Loading the battery

### If your package includes a battery charger

If your package includes a battery charger, use it to charge the available Kodak Ni-MH rechargeable battery.

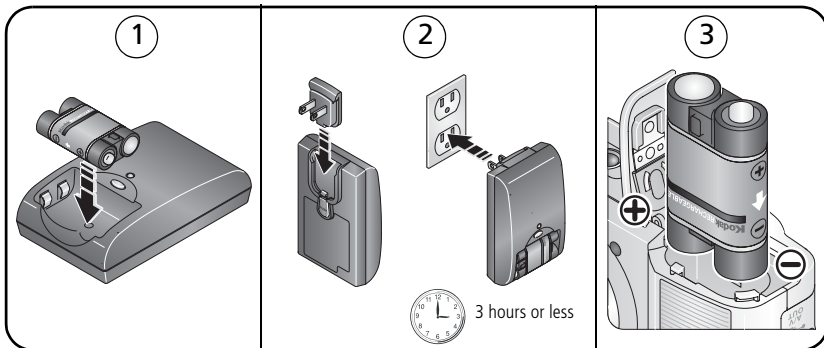

### If your package includes an EasyShare dock

If your package includes an EasyShare dock, use it to charge the available Kodak Ni-MH rechargeable digital camera battery. (See the dock user's guide for details.)

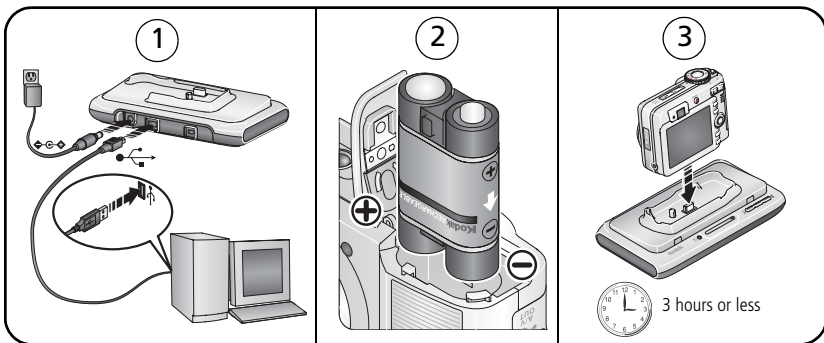



## If your package does not include a dock or charger

Install other batteries as shown.

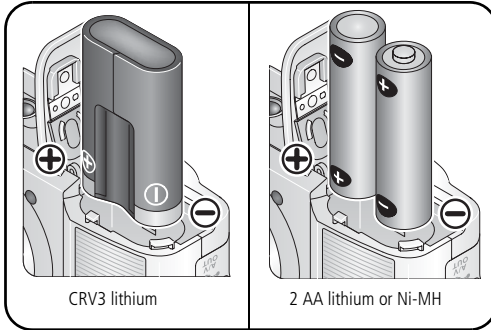

To extend battery life, see [page 57](#).

## Turning on the camera

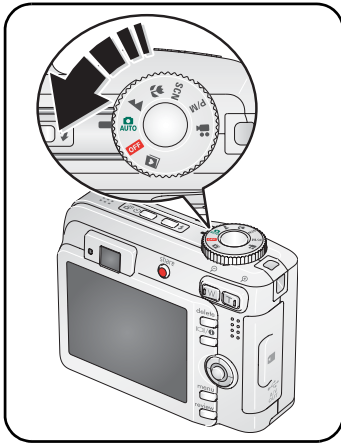

## Setting the language, date/time

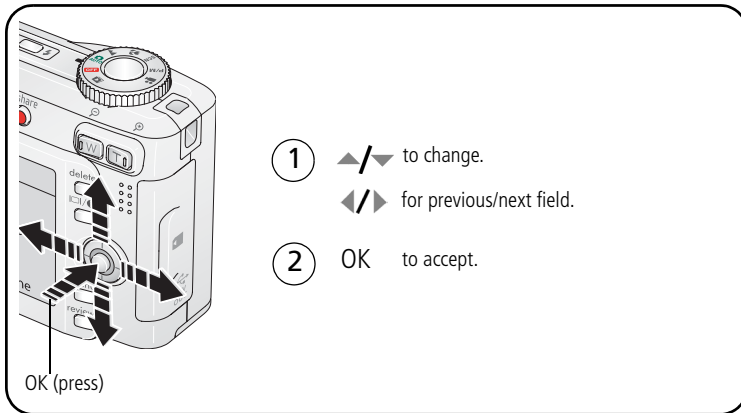

## Setting the language, date/time in the future

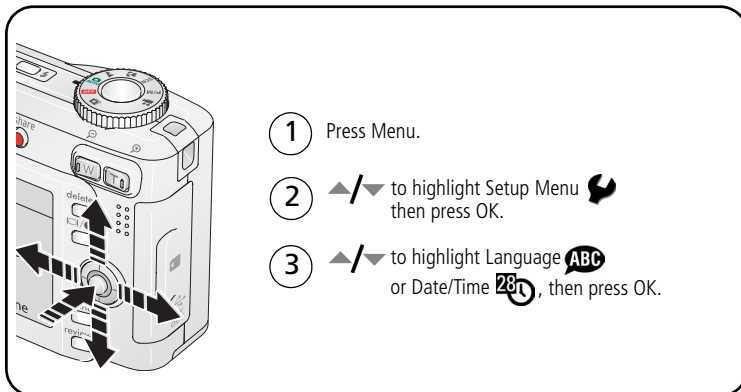

## Storing pictures on an SD or MMC card

Your camera has internal memory. You can purchase an SD or MMC card to conveniently store more pictures and videos.

NOTE: When using the card for the first time, format it in this camera before taking pictures (see [page 33](#)). We recommend Kodak SD or MMC cards.

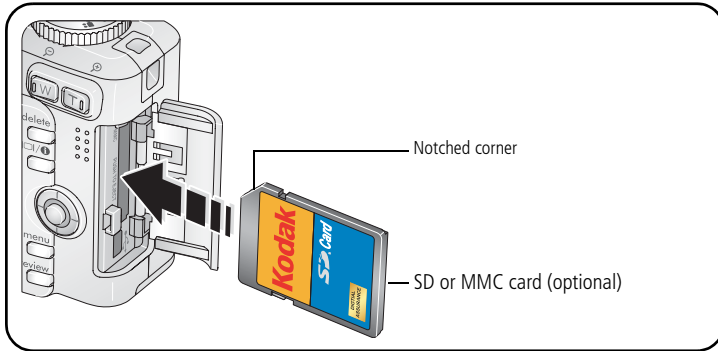





### CAUTION:

**A card can only be inserted one way; forcing it may cause damage. Inserting or removing a card when the Ready light is blinking may damage the pictures, the card, or the camera.**

See [page 55](#) for storage capacities. Purchase SD or MMC cards at a dealer of Kodak products or [www.kodak.com/go/C663accessories](http://www.kodak.com/go/C663accessories).

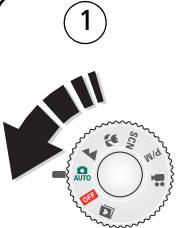
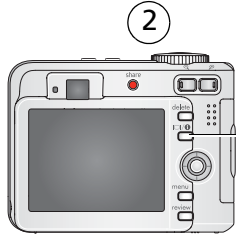
## 2 Taking pictures and videos

### Taking a picture

<p>1</p> 	<p>2</p>  <p>LCD/Info</p> <p>Use the LCD or viewfinder.</p> <p>Press LCD/Info   for:</p> <ul style="list-style-type: none"><li>• LCD on, status icons, histogram on</li><li>• LCD, status icons off</li><li>• LCD off (use the viewfinder)</li></ul>	<p>3</p>  <p>Press the Shutter button halfway to focus and set exposure. When the Ready light turns green, press the Shutter button completely down.</p>
--------------------------------------------------------------------------------------------	---------------------------------------------------------------------------------------------------------------------------------------------------------------------------------------------------------------------------------------------------------------------------------------------------------------------------------------------------------------------------------------------------------------------------------------------------------------------------------------------------------	-------------------------------------------------------------------------------------------------------------------------------------------------------------------------------------------------------------------------------------------

### Taking a video

<p>1</p> 	<p>2</p>  <p>Press the Shutter button completely down and release. To stop recording, press and release the Shutter button again.</p>
---------------------------------------------------------------------------------------------	-------------------------------------------------------------------------------------------------------------------------------------------------------------------------------------------------------------------------

## Reviewing the picture or video just taken

After you take a picture or video, the LCD displays a quickview for approximately 5 seconds.

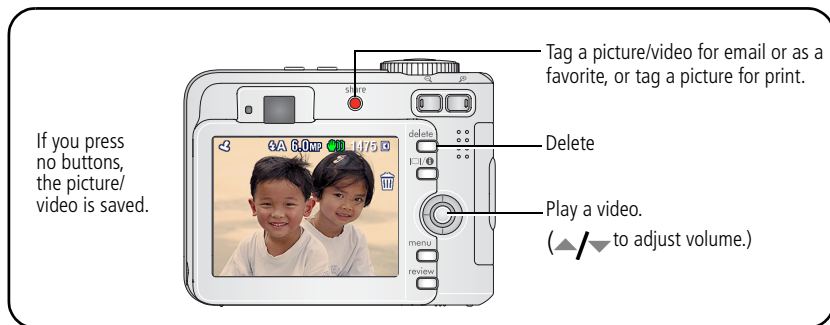

To review pictures and videos anytime, see [page 10](#).

### Understanding quickview blur warning icons

If the feature is turned on (see [page 33](#)), a picture blur warning icon  is displayed during quickview.

**Green**—Picture is sharp enough for an acceptable 4 x 6-inch (10 x 15 cm) print.

**Yellow**—Picture may be sharp enough for an acceptable 4 x 6-inch print or sharpness is not determined.

**Red**—Picture is not sharp enough for an acceptable 4 x 6-inch print.

**White**—Printability is still being determined.

## Understanding picture-taking icons

In capture mode—no buttons pressed

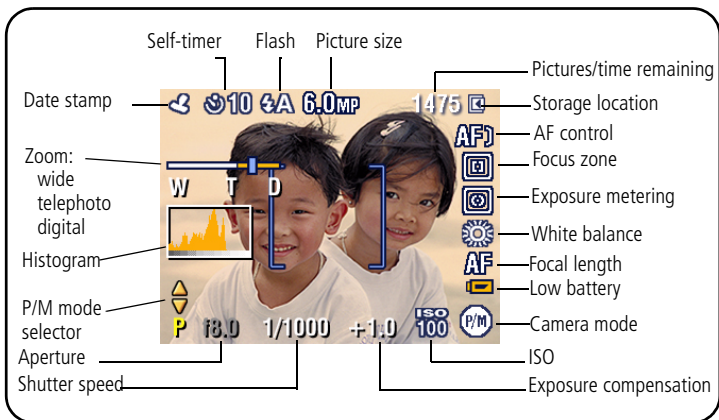

In capture mode—shutter pressed halfway

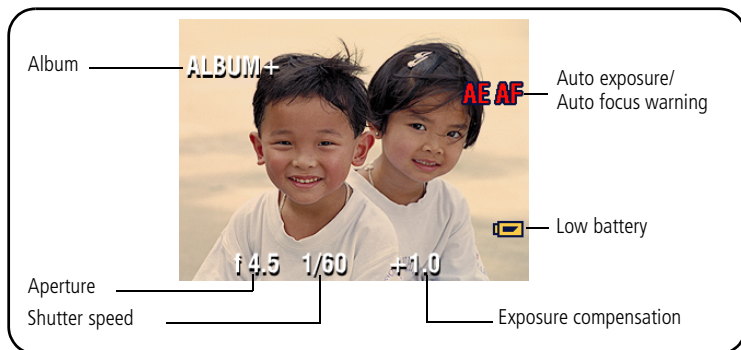

## Using the auto-focus framing marks (to take pictures)

When using the LCD as a viewfinder, framing marks indicate the camera focus area. The camera attempts to focus on foreground subjects, even if the subjects are not centered in the scene.

- 1 Press the Shutter button **halfway**.

*When the framing marks turn green, focus is accomplished.*

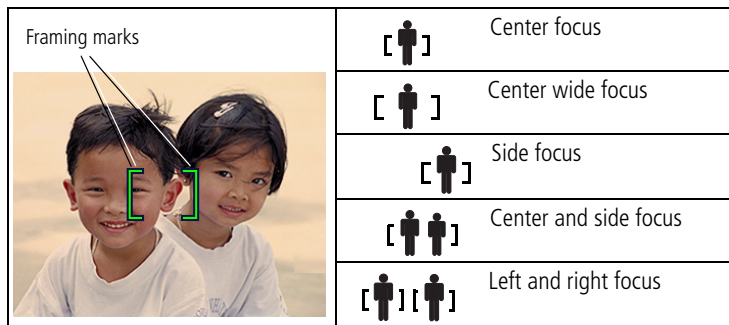

- 2 If the camera is not focusing on the desired subject (or if the framing marks disappear), release the Shutter button and recompose the scene.
- 3 Press the Shutter button **completely down** to take the picture.

NOTE: Framing marks do not appear in Landscape or Video mode. When you use Focus Zone (see [page 29](#)) and set Center Zone, the framing marks are fixed at Center Wide.

## Reviewing pictures and videos on your camera

Press the Review button to view and work with your pictures and videos.



**1** Review.  
(Press again to exit.)

**2** ◀/▶ for previous/next.

**Videos:**

- OK Play/pause.
- ▲/▼ Adjust the volume.
- ◀ Rewind to beginning (during playback).
- ▶ Next picture/video (during playback).

To save battery power, use an optional Kodak EasyShare dock or Kodak 3-volt AC adapter. (See [www.kodak.com/go/C663accessories](http://www.kodak.com/go/C663accessories).)

NOTE: Pictures taken at the 5 MP (3:2) quality setting are displayed at a 3:2 aspect ratio with a black bar at the top of the screen. A video's duration is displayed at the top of the LCD.

### Magnifying a picture during review

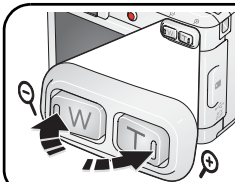

W/T magnify 1X - 8X.

◀/▶ ▲/▼ view other parts of the picture.

OK return to 1X.

### Viewing multi-up (thumbnails) during review

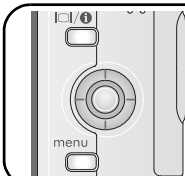

▼ view multi-up thumbnails.

▲/▼ view previous/next row of thumbnails.

◀/▶ view previous/next thumbnail.

OK view single picture.



## Understanding review icons

### Pictures

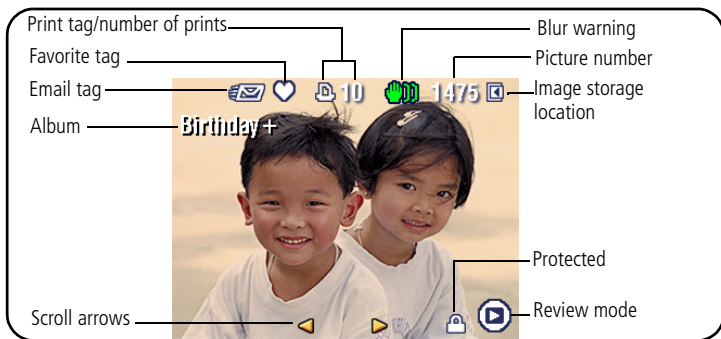

### Videos

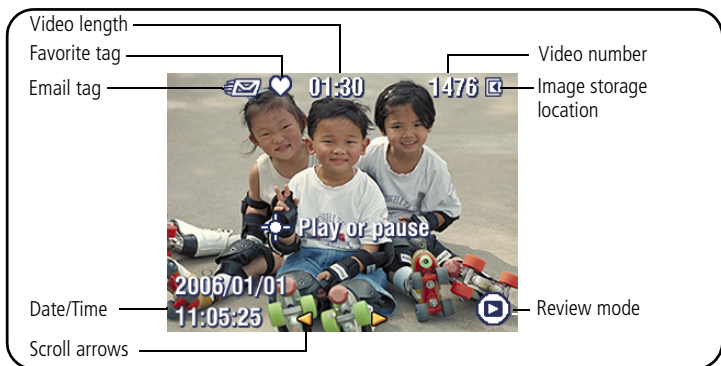

## Deleting pictures and videos during review



- 1 Press Review.
- 2 ◀▶ for previous/next.
- 3 Press Delete.
- 4 Follow the screen prompts.

## Using the undo delete feature

If you accidentally delete a picture/video, you may be able to use Undo Delete to retrieve it. This feature is only available immediately after you delete a picture/video.

## Protecting pictures and videos from deletion



- 1 Press Review.
- 2 ◀▶ for previous/next.
- 3 Press Menu.
- 4 Press ▲/▼ to highlight Protect, then press OK.

*The picture or video is protected and cannot be deleted. The Protect icon  appears with the protected picture or video.*

Press the Menu button to exit the menu.

# 3

## Transferring and printing pictures

### Installing the software



#### CAUTION:

**Install EasyShare software *before* connecting the camera to the computer. Failure to do so may cause the software to load incorrectly.**

- 1 Close all software applications that are open on your computer (including anti-virus software).
- 2 Place the EasyShare software CD into the CD-ROM drive.
- 3 Load the software:  
**Windows OS**—if the install window does not appear, choose Run from the Start menu and type **d:\setup.exe** where **d** is the drive letter that contains the CD.  
**Mac OS X**—double-click the CD icon on the desktop, then click the Install icon.
- 4 Follow the on-screen instructions to install the software.
- 5 If prompted, restart the computer. If you turned off anti-virus software, turn it back on. See the anti-virus software manual for details.

## Transferring pictures

### If your package includes an EasyShare dock

If your package includes an EasyShare camera or printer dock, use the dock to transfer pictures to your computer. (For details, see the dock user's guide. To purchase accessories, see [www.kodak.com/go/c663accessories](http://www.kodak.com/go/c663accessories). For dock compatibility, see page 18.)

### If your package does not include an EasyShare dock

If your package does not include an EasyShare dock, use the USB cable (U-8) that came with your camera. (The U-8 cable is **not** included with an EasyShare dock.)

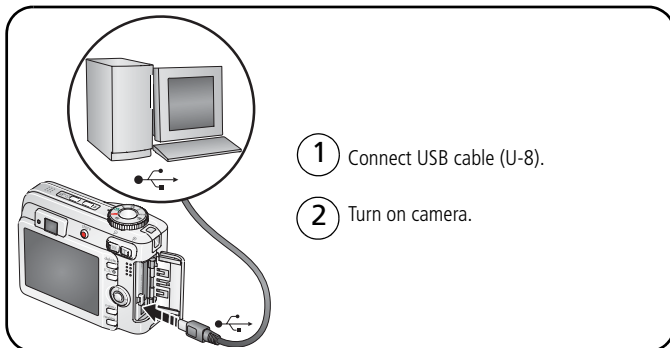

NOTE: Visit [www.kodak.com/go/howto](http://www.kodak.com/go/howto) for an online tutorial on connecting.

### Also available for transferring

You can also use Kodak card readers to transfer your pictures and videos. Purchase these and other accessories at a dealer of Kodak products or [www.kodak.com/go/C663accessories](http://www.kodak.com/go/C663accessories).

## Printing pictures

### Printing with a Kodak EasyShare printer dock

Dock your camera to the Kodak EasyShare printer dock and print directly—with or without a computer. Purchase this and other accessories at a dealer of Kodak products or visit [www.kodak.com/go/C663accessories](http://www.kodak.com/go/C663accessories).

### Direct printing with a PictBridge enabled printer

Your camera is compatible with PictBridge technology, so you can print directly to PictBridge enabled printers. You need:

- Camera with fully charged batteries
- PictBridge enabled printer
- USB cable (may be sold separately)

### Connecting the camera to a PictBridge enabled printer

- 1 Turn off the camera and printer.
- 2 Connect the USB cable from the camera to the printer. (See your printer user guide or visit [www.kodak.com/go/C663accessories](http://www.kodak.com/go/C663accessories).)

## Printing from a PictBridge enabled printer

- 1 Turn on the printer. Turn on the camera.

*The PictBridge logo is displayed, followed by the current picture and menu. (If no pictures are found, a message is displayed.) If the menu interface turns off, press any button to redisplay it.*

- 2 Press ▲/▼ to choose a printing option, then press the OK button.

<b>Current Picture</b>	Press ◀/▶ to choose a picture. Choose the number of copies.
<b>Tagged Pictures</b>	If your printer is capable, print pictures that you tagged for printing and choose a print size.
<b>Index Print</b>	Print thumbnails of all pictures. This option requires one or more sheets of paper. If the printer is capable, choose a print size.
<b>All Pictures</b>	Print all pictures in internal memory, on a card, or in Favorites. Choose the number of copies.
<b>Image Storage</b>	Access internal memory, a card, or Favorites.

NOTE: During direct printing, pictures are not permanently transferred or saved to the computer or printer.

## Disconnecting the camera from a PictBridge enabled printer

- 1 Turn off the camera and printer.
- 2 Disconnect the USB cable from the camera and the printer.

## Using a printer that is not PictBridge enabled

See EasyShare software Help for details.

## Ordering prints online

Kodak EasyShare Gallery ([www.kodakgallery.com](http://www.kodakgallery.com)) is one of the many online print services offered in the Kodak EasyShare software. You can easily:

- Upload your pictures.
- Edit, enhance, and add borders to your pictures.
- Store pictures, and share them with family and friends.
- Order high-quality prints, photo greeting cards, frames, and albums—and have them delivered to your door.

## Printing from an optional SD/MMC card

- Automatically print tagged pictures when you insert your card into a printer with an SD/MMC card slot. See your printer user's guide for details.
- Make prints at an SD/MMC card-capable Kodak picture maker. (Contact a location prior to visiting. See [www.kodak.com/go/picturemaker](http://www.kodak.com/go/picturemaker).)
- Take the card to your local photo retailer for professional printing.

## Dock compatibility for your camera

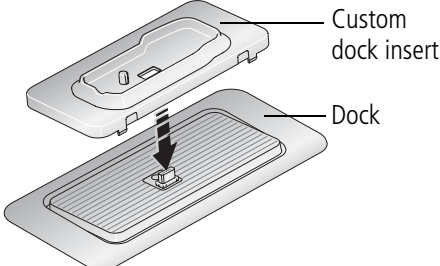
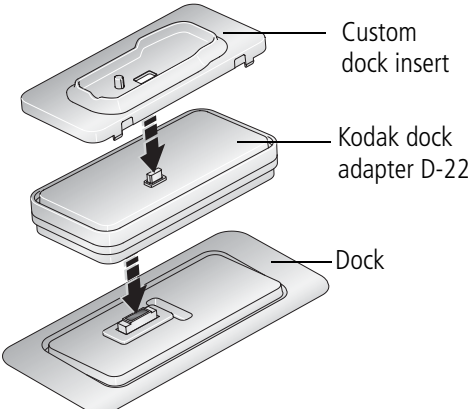
Kodak EasyShare dock	Docking configuration
<ul style="list-style-type: none"> <li>■ printer dock plus series 3</li> <li>■ printer docks and camera docks series 3</li> </ul>	 <p>Custom dock insert</p> <p>Dock</p>
<p>Others, including:</p> <ul style="list-style-type: none"> <li>■ printer dock</li> <li>■ printer dock plus</li> <li>■ printer dock 6000</li> <li>■ camera dock 6000</li> </ul>	 <p>Custom dock insert</p> <p>Kodak dock adapter D-22</p> <p>Dock</p>
<ul style="list-style-type: none"> <li>■ printer dock 4000</li> <li>■ camera dock II</li> <li>■ LS420, LS443 camera dock</li> </ul>	<p>Not compatible</p>

Purchase camera docks, printer docks, and other accessories at a dealer of Kodak products or [www.kodak.com/go/C663accessories](http://www.kodak.com/go/C663accessories).



# 4

## Doing more with your camera

### Using optical zoom

Use optical zoom to get up to 3X closer to your subject. Optical zoom is effective when the lens is no closer than 24 in. (60 cm) to the subject or 2 in. (5 cm) in Close-up mode. You can change optical zoom before (but not during) video recording.

- 1 Use the viewfinder or LCD to frame your subject.
- 2 Press Telephoto (T) to zoom in. Press Wide Angle (W) to zoom out.

*The zoom indicator shows zoom status.*

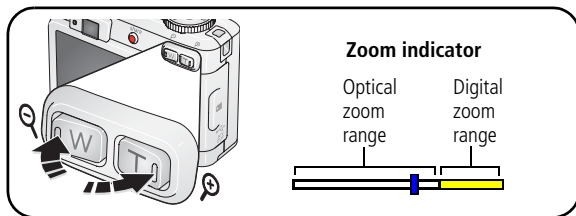

- 3 Take the picture or video.

### Using digital zoom

Use digital zoom in any Still mode to get up to 15X magnification.



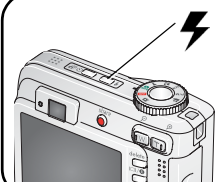

- 1 Press the Telephoto (T) button to the optical zoom limit (3X). Release the button, then press it again.
- 2 Take the picture or video.

**NOTE:** You cannot use digital zoom for video recording. You may notice decreased image quality when using digital zoom. The blue slider on the zoom indicator pauses and turns red when the picture quality reaches the limit for an acceptable 4 x 6-in. (10 x 15 cm) print.

## Changing the flash settings



Press the flash button repeatedly to scroll through flash modes. The current flash mode is shown in the LCD status area.





Flash modes	Flash fires	
 <b>Auto Flash</b>	When the lighting conditions require it.	
 <b>Fill</b>	Every time you take a picture, regardless of the lighting conditions. Use when the subject is in shadow or is "backlit" (when the sun is behind the subject). In low light, hold the camera steady or use a tripod.	
 <b>Red Eye</b>	If the Red Eye Preflash feature is turned off: <ul style="list-style-type: none"> <li>■ The flash fires once.</li> <li>■ The camera then automatically corrects red eye in the picture.</li> </ul>	If the Red Eye Preflash feature is turned on: <ul style="list-style-type: none"> <li>■ The flash fires once so the eyes become accustomed to the flash, then fires again when the picture is taken.</li> <li>■ The camera then automatically corrects red eye in the picture.</li> </ul>
 <b>Off</b>	Never	

To turn the Red Eye Preflash feature on/off, see [page 33](#).

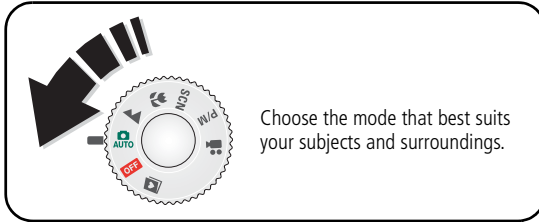
For flash settings in each mode, see [page 54](#).

## Picture-taking modes



Use this mode	For
 <b>Auto</b> <b>AUTO</b>	General picture-taking—offers an excellent balance of image quality and ease of use.
 <b>Landscape</b>	Far-away scenes. The camera uses infinity auto-focus. Auto-focus framing marks are not available in Landscape.
 <b>Close-up</b>	Close range. Use available light instead of flash if possible. The camera automatically sets the focus distance depending on the zoom position.
<b>SCN</b> <b>Scene</b>	Point-and-shoot simplicity when taking pictures under special conditions. (See <a href="#">page 22</a> .)
<b>P/M</b> <b>P/M</b>	More creative control. (See <a href="#">page 24</a> .)
 <b>Video</b>	Capturing video with sound. (See <a href="#">page 6</a> .)

For flash settings in each mode, see [page 54](#).

## Scene modes

- 1 Turn the Mode dial to Scene **SCN**.
- 2 Press ◀/▶ to display Scene mode descriptions.

NOTE: If the Help text turns off, press the OK button.

- 3 Press the OK button to choose a Scene mode.

Use this SCN mode	For
<b>Portrait</b>	Full-frame portraits of people.
<b>Sport</b>	Subjects that are in motion.
<b>Children</b>	Action pictures of children in bright light.
<b>Party</b>	People indoors. Minimizes red eye.
<b>Beach</b>	Bright beach scenes.
<b>Snow</b>	Bright snow scenes.
<b>Fireworks</b>	Flash does not fire. Place the camera on a flat, steady surface or use a tripod.
<b>Flower</b>	Close-ups of flowers or other small subjects in bright light.
<b>Self-Portrait</b>	Close-ups of yourself. Assures proper focus and minimizes red eye.
<b>Backlight</b>	Subjects that are in shadow or “backlit” (when light is behind the subject).
<b>Night Portrait</b>	Reduces red eye of people in night scenes or low-light conditions. Place the camera on a flat, steady surface or use a tripod.
<b>Night Landscape</b>	Distant scenery at night. Flash does not fire. Place the camera on a flat, steady surface or use a tripod.
<b>Manner/Museum</b>	Quiet occasions, like a wedding or lecture. Flash and sound are disabled.
<b>Text</b>	Documents.

For flash settings in each mode, see [page 54](#).

## Using exposure compensation to adjust brightness

In Auto, Landscape, Close-up, and P modes, you can adjust exposure compensation to make your pictures darker or lighter. Press ▲ to increase exposure compensation, and ▼ to decrease exposure compensation.

The exposure compensation level is shown on the LCD +0.3 and the LCD gets brighter or dimmer.

## Using the histogram to view picture brightness

Use the histogram to evaluate the distribution of light before or after you take a picture. If the peak is to the right of the graph, the subject is bright; if the peak is to the left, the subject is dark. Optimal exposure is achieved when the peak is in the middle of the histogram.

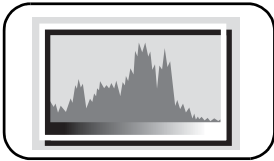

To turn on the histogram in Auto, Landscape, Close-up, SCN, P/M, or Review, press the LCD/Info  button until the histogram appears.

**NOTE:** If a scene is dark or light, you can adjust the exposure compensation before taking the picture.

## Using P/M modes

- 1 Turn the Mode dial to **P/M** .
- 2 Press ◀/▶ to display P/M mode descriptions.
- 3 Press the OK button to choose a P/M mode.

Use this mode	For
<b>P</b> Program	Controlling exposure compensation (how much light enters the camera) and flash compensation. The camera automatically sets the shutter speed and aperture (f-stop) based on the scene lighting. Program mode offers the ease of auto shooting with full access to all menu options. Use the joystick to select settings. (See <a href="#">Changing P/M mode settings, page 25.</a> ) Press the Menu button to change other settings.
<b>M</b> Manual	The highest level of creative control. You set the aperture, shutter speed, and ISO speed. Exposure compensation acts as an exposure meter, recommending the proper combination of aperture and shutter speed to produce an acceptable exposure. Use the joystick to select settings. (See <a href="#">Changing P/M mode settings, page 25.</a> ) Press the Menu button to change other settings. To prevent camera shake, use a tripod for slow shutter speeds.

## Changing P/M mode settings

P/M modes control the f-number, shutter speed, and exposure compensation. Use the Menu button to control all other settings.

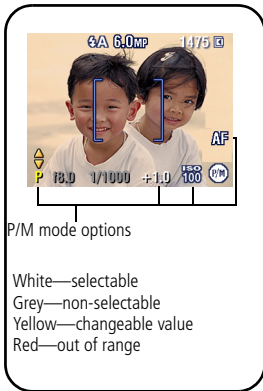

- 1 Turn the Mode dial to P/M.  
*The mode options are displayed.*
- 2 Move the joystick ▲/▼ to choose P or M.
- 3 Press ▲/▼ ◀/▶ to:
  - Move between available settings.
  - Open a setting.
  - Change the setting.
- 4 Press the Menu button to change other settings (see [page 28](#)).
- 5 Take a picture.

## Settings apply only in P/M

Settings you change in P or M modes apply only to pictures taken in P/M modes.

For example, if you change the Color Mode to Sepia while in P or M mode, then Auto & Scene modes retain the default setting of Color.

NOTE: The settings, including Flash, are maintained for P/M modes—even when you change modes or turn off the camera.

## Using the self-timer

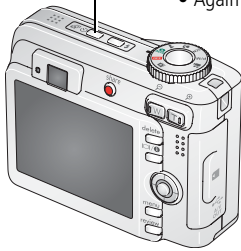

- 1 Place camera on a tripod or flat surface.
- 2 In any Still mode, press 
  - Once for a 10-second delay (so you have time to get into the scene)
  - Again for a 2-second delay (for a steady, auto-shutter release on a tripod)
  - Again for 2 pictures (after a 10- and 18-second delay)
- 3 Compose the scene.
- 4 Press the Shutter button halfway, then completely down.

To cancel the Self-timer before the picture is taken, press the Self-timer button. (The Self-timer setting remains active.)



### Use the same procedure to take a video, but:

- Turn the Mode dial to Video .
- Press the Shutter button completely down.

NOTE: The video stops when no storage space remains. Only the 2- and 10-second options are available in video mode.

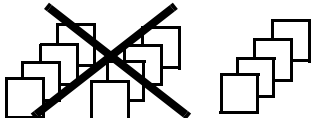

## Using burst

Option	Description	Purpose
 <b>First Burst</b>	Camera takes up to 5 pictures (2 per second) while the Shutter button is pressed.   First 4 pictures are saved.	Capture an expected event.  <b>Example:</b> A person swinging a golf club.
 <b>Last Burst</b>	Camera takes up to 30 pictures (2 per second for up to 15 seconds) while the Shutter button is pressed. When the Shutter button is released, only the last 4 pictures are saved.   Last 4 pictures are saved.	Capture an event when the precise timing is uncertain.  <b>Example:</b> A child blowing out birthday candles.

- 1 In most Still modes, press the Burst button repeatedly to choose an option.
- 2 Press the Shutter button **halfway** to focus and set exposure.
- 3 Press the Shutter button **completely down and hold it** to take pictures.

*The camera stops taking pictures when you release the Shutter button, when the pictures are taken, or when there is no more storage space.*

NOTE: During quickview, you can delete all pictures in the burst series. To delete selectively, do so in Review (see [page 12](#)).

## Changing picture-taking settings

You can change settings to get the best results from your camera:

- 1 Press the Menu button.
- 2 Press  $\blacktriangle/\blacktriangledown$  to highlight a setting, then press the OK button.
- 3 Choose an option, then press the OK button. (Press the Menu button to exit.)

NOTE: Some settings are unavailable in some modes.

Setting	Options
<p><b>Exposure Bracketing</b></p> <p>Determine the best exposure level for your conditions based on your evaluation of 3 pictures.</p> <p><i>This setting remains until you turn the Mode dial.</i></p>	<p><b>Off</b></p> <p><b>+/- 0.3</b></p> <p><b>+/- 0.7</b></p> <p><b>+/- 1.0</b></p> <p>The camera takes 3 pictures—at +, at 0, and at - exposure.</p>
<p><b>Exposure Compensation</b></p> <p>Control how much light enters the camera.</p> <p><i>This setting remains until you turn the Mode dial.</i></p>	<p>-2.0 to +2.0 (in 1/3 increments)</p>
<p><b>Picture Size</b></p> <p>Choose a picture resolution.</p> <p><i>This setting remains until you change it.</i></p>	<p><b>6 MP</b>—for printing up to 20 x 30 in. (51 x 76 cm); pictures are highest resolution and largest file size.</p> <p><b>5 MP (3:2) (default)</b>—ideal for printing 4 x 6 in. (10 x 15 cm) prints without cropping. Also for printing up to 20 x 30 in. (51 x 76 cm).</p> <p><b>4 MP</b>—for printing up to 20 x 30 in. (51 x 76 cm); pictures are medium resolution with smaller file size</p> <p><b>3 MP</b>—for printing up to 11 x 14 in. (28 x 36 cm); pictures are medium resolution with smaller file size.</p> <p><b>1 MP</b>—for printing 4 x 6 in. (10 x 15 cm), emailing, Internet, screen display, or for conserving space.</p>

Setting	Options
<p><b>White Balance</b> Choose your lighting condition. <i>This setting remains until you turn the Mode dial.</i></p>	<p><b>Auto (default)</b>—automatically corrects white balance. Ideal for general picture taking.</p> <p><b>Daylight</b>—for pictures in natural lighting.</p> <p><b>Tungsten</b>—corrects the orange cast of household light bulbs. Ideal for indoor pictures under tungsten or halogen lighting without flash.</p> <p><b>Fluorescent</b>—corrects the green cast of fluorescent lighting. Ideal for indoor pictures under fluorescent lighting without flash.</p> <p><b>Open Shade</b>—for pictures in shade in natural lighting. Available only in P/M mode.</p>
<p><b>Exposure Metering</b> Evaluate light levels at specific areas of a scene. <i>This setting remains until you turn the Mode dial.</i></p>	<p><b>Multi-pattern (default)</b>—evaluates lighting conditions throughout the image to give an optimum picture exposure. Ideal for general picture taking.</p> <p><b>Center-weight</b>—evaluates the lighting conditions of the subject centered in the viewfinder. Ideal for backlit subjects.</p> <p><b>Center-spot</b>—similar to Center-weight, except the metering is concentrated on a smaller area of the subject centered in the viewfinder. Ideal when you need an exact exposure of a specific area in the picture. Available only in P/M mode.</p>
<p><b>Focus Zone</b> Select a large or concentrated area of focus. <i>This setting remains until you turn the Mode dial.</i></p>	<p><b>Multi-zone (default)</b>—evaluates 3 zones to give an even picture focus. Ideal for general picture taking.</p> <p><b>Center-zone</b>—evaluates the small area centered in the viewfinder. Ideal when precise focus of a specific area in the picture is needed. Available only in P/M mode.</p> <p>NOTE: For the best pictures, the camera is set to Multi-zone when in Landscape mode.</p>

Setting	Options
<p><b>AF Control</b> Choose an auto-focus setting. <i>This setting remains until you change it.</i></p>	<p><b>Continuous AF</b>—uses external AF sensor and TTL (Through The Lens) AF. Because the camera is always focusing, there is no need to press the Shutter button halfway down to focus.</p> <p><b>Single AF (default)</b>—uses external AF sensor and TTL-AF when the Shutter button is pressed halfway down.</p>
<p><b>Color Mode</b> Choose color tones. <i>This setting remains until you turn the Mode dial.</i></p>	<p><b>High Color</b> <b>Natural Color (default)</b> <b>Low Color</b> <b>Black &amp; White</b> <b>Sepia</b>—for pictures with a reddish-brown, antique look. NOTE: EasyShare software also lets you change a color picture to black-and-white or sepia. Unavailable in Video mode.</p>
<p><b>Sharpness</b> Control picture sharpness. <i>This setting remains until you turn off the camera.</i></p>	<p><b>High</b> <b>Normal (default)</b> <b>Low</b> Available only in P/M mode.</p>
<p><b>Reset to Default</b></p>	<p>All picture-taking settings return to their default. Available only in P/M mode.</p>
<p><b>Set Album</b> Choose Album names. <i>This setting remains until you change it. You can apply different Set Album choices to videos and to pictures.</i></p>	<p><b>On</b> <b>Off (default)</b> Pre-select album names before you take pictures or videos. Then, all the pictures or videos you take are tagged with those album names. See <a href="#">page 38</a>.</p>

Setting	Options
<b>Image Storage</b> Choose a storage location for pictures/videos. <i>This setting remains until you change it.</i>	<b>Auto (default)</b> —the camera uses the card if one is in the camera. If not, the camera uses internal memory. <b>Internal Memory</b> —the camera always uses internal memory, even if a card is installed. NOTE: If you fill up a storage location while taking pictures, the camera prompts you to switch to the other storage location.
<b>Video Size</b>	<b>640 x 240</b> <b>320 x 240</b> Available only in Video mode.
<b>Video Length</b>	<b>Continuous (default)</b> <b>5 seconds</b> <b>15 seconds</b> <b>30 seconds</b> Available only in Video mode.
<b>Setup Menu</b>	See <a href="#">Customizing your camera</a> .

## Customizing your camera

Use Setup to customize your camera settings.

- 1 In any mode, press the Menu button.
- 2 Press  $\blacktriangle/\blacktriangledown$  to highlight Setup , then press the OK button.
- 3 Press  $\blacktriangle/\blacktriangledown$  to highlight the setting you wish to change, then press the OK button.
- 4 Choose an option, then press the OK button. (Press the Menu button to exit.)

NOTE: These settings remain until you change them.

Setting	Options
<b>Return</b> to previous menu.	

Setting	Options
<p><b>Liveview</b> Change liveview default to on or off. NOTE: In some modes, the LCD turns on even if the liveview option is set to Off. (To turn the LCD on/off any time, press the LCD/Info button.)</p>	<p><b>On (default)</b> <b>Off</b></p>
<p><b>Camera Sounds</b> Choose sound effects.</p>	<p><b>Theme</b>—applies the same sound effect set to all functions. <b>Individual</b>—choose a sound effect for each function.</p>
<p><b>Sound Volume</b></p>	<p><b>Off</b> <b>Low (default)</b> <b>Medium</b> <b>High</b></p>
<p><b>LCD Brightness</b> Choose inactivity time until LCD dims. <i>This setting remains until you turn off the camera.</i></p>	<p><b>Power Save (default)</b> <b>High Power</b></p>
<p><b>Auto Power Off</b> Choose inactivity time until camera turns off.</p>	<p><b>10 minutes</b> <b>5 minutes</b> <b>3 minutes (default)</b> <b>1 minute</b></p>
<p><b>Date &amp; Time</b></p>	<p>See <a href="#">page 4</a>.</p>
<p><b>Video Out</b> Choose the regional setting that lets you connect the camera to a television or other external device.</p>	<p><b>NTSC (default)</b>—used in North America and Japan; most common format. <b>PAL</b>—used in Europe and China.</p>

Setting	Options
<b>Orientation Sensor</b> Orient pictures so that they are displayed with the correct side up.	<b>On (default)</b> <b>Off</b>
<b>Red Eye Preflash</b> Choose if the Red Eye flash fires automatically before a picture is taken. NOTE: The camera automatically corrects red eye, even if the Red Eye Preflash is set to Off.	<b>On</b> <b>Off (default)</b>
<b>Date Stamp</b> Imprint the date on pictures.	<b>On</b> <b>Off (default)</b>
<b>Video Date Display</b> Display Date/Time at the start of video playback.	<b>On (default)</b> —choose from date formats. <b>Off</b>
<b>Blur Warning</b>	<b>On (default)</b> <b>Off</b> (See <a href="#">page 7.</a> )
<b>Language</b>	See <a href="#">page 4.</a>
<b>Format</b>  <b>CAUTION:</b> <b>Formatting deletes all pictures/videos, including those that are protected. Removing a card during formatting may damage the card.</b>	<b>Memory Card</b> —deletes everything on the card; formats the card. <b>Cancel</b> —exits without making a change. <b>Internal Memory</b> —deletes everything in internal memory including email addresses, album names, and favorites; formats the internal memory. Use EasyShare software to restore addresses and albums.
<b>About</b> View camera information.	

## Running a slide show

Use the Slide Show to display your pictures/videos on the LCD. To run a slide show on a television or on any external device, see [page 35](#). To save battery power, use an optional Kodak 3-volt AC adapter. (Visit [www.kodak.com/go/C663accessories](http://www.kodak.com/go/C663accessories).)

### Starting the slide show

- 1 Press the Review button, then press the Menu button.
- 2 Press  $\blacktriangle/\blacktriangledown$  to highlight Slide Show , then press the OK button.
- 3 Press  $\blacktriangle/\blacktriangledown$  to highlight Begin Show, then press the OK button.

*Each picture and video is displayed once.*

To interrupt the Slide Show, press the OK button.

### Changing the slide show display interval

The default interval setting displays each picture for 5 seconds. You can set the display interval from 3 to 60 seconds.

- 1 On the Slide Show menu, press  $\blacktriangle/\blacktriangledown$  to highlight Interval, then press the OK button.
- 2 Select a display interval.
- 3 Press the OK button.

*The interval setting remains until you change it.*

### Running a continuous slide show loop

When you turn on Loop, the slide show is continuously repeated.

- 1 On the Slide Show menu, press  $\blacktriangle/\blacktriangledown$  to highlight Loop, then press the OK button.
- 2 Press  $\blacktriangle/\blacktriangledown$  to highlight On, then press the OK button.

*The slide show repeats until you press the OK button or until battery power is exhausted. The Loop feature remains until you change it.*



## Displaying pictures and videos on a television

You can display pictures/videos on a television, computer monitor, or any device equipped with a video input. (Image quality on a television screen may not be as good as on a computer monitor or when printed.)

NOTE: Ensure that the Video Out setting (NTSC or PAL) is correct (see [page 32](#)). The slide show stops if you connect a cable while the slide show is running.



- 1 Connect the audio/video cable (included) from the camera USB, A/V Out port to the television video-in port (yellow) and audio-in port (white). See your television user's guide for details.
- 2 Review pictures/videos on the television.

## Using Kodak Perfect Touch technology

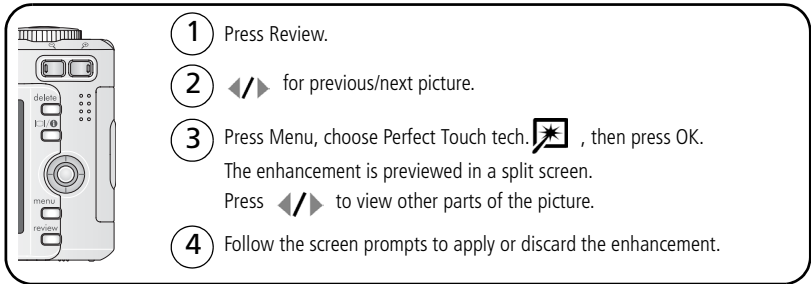
Kodak Perfect Touch technology helps ensure better, brighter pictures.



The diagram shows a camera's control panel with four numbered steps:

- 1 Press Review.
- 2  for previous/next picture.
- 3 Press Menu, choose Perfect Touch tech. , then press OK. The enhancement is previewed in a split screen. Press  to view other parts of the picture.
- 4 Follow the screen prompts to apply or discard the enhancement.

*The picture is copied, then enhanced. (The original picture is saved.) An enhanced picture cannot be enhanced again on the camera. Kodak Perfect Touch technology can only be used with pictures, not video.*

Press the Menu button to exit the menu.

## Cropping pictures



- 1 Press Review.
- 2 ◀/▶ for previous/next picture.
- 3 Press Menu, choose Crop , then press OK.
- 4 Press Telephoto (T) to zoom in, or ◀/▶ ▶/◀ to move the crop box, then press OK.
- 5 Follow the screen prompts.

The picture is copied, then cropped. (The original picture is saved.) A cropped picture cannot be cropped again on the camera.

Press the Menu button to exit the menu.

## Making a video action print

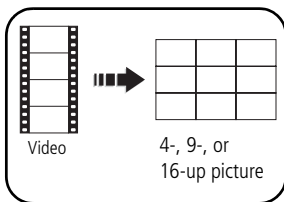

From a video, you can make a 4-, 9-, or 16-up picture. The camera chooses the first and last frames, then 2, 7, or 14 equally spaced frames from the video. The picture is suitable for a 4 x 6-inch (10 x 15 cm) print.

- 1 Press the Review button, then press ◀/▶ to locate a video.
  - 2 Press the Menu button, choose Action Print, then press the OK button.
  - 3 Choose an option, then press the OK button.  
*A 4-, 9-, and 16-up picture is created. (The original video is saved.)*
- Press the Menu button to exit the menu.

## Viewing picture/video information

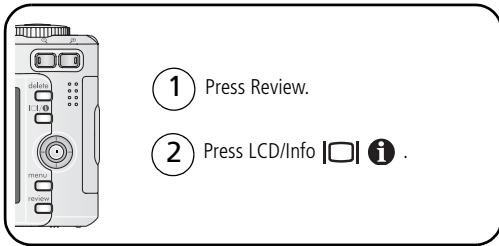

To exit Review, press the Review button.

## Copying pictures and videos

You can copy pictures/videos from a card to internal memory or from internal memory to a card.

### Before you copy, make sure that:

- A card is inserted in the camera.
- The camera's picture storage location is set to the location **from** which you are copying. (See [page 31](#).)

### Copy pictures or videos:

- 1 Press the Review button, then press the Menu button.
- 2 Press  $\blacktriangle/\blacktriangledown$  to highlight Copy  $\blacktriangleright\blacktriangleright$ , then press the OK button.
- 3 Press  $\blacktriangle/\blacktriangledown$  to highlight an option.
- 4 Press the OK button.

NOTE: Pictures/videos are copied, not moved. To remove pictures/videos from the original location after copying, delete them (see [page 12](#)). Tags that you applied for print, email, and favorites are not copied. Protection settings are not copied. To apply protection to a picture or video, see [page 12](#).

## Pre-tagging for album names

Use the Set Album (Still or Video) feature to pre-select album names before you take pictures or videos. Then, all the pictures or videos you take are tagged with those album names.

### First—on your computer

Use the EasyShare software that was packaged with your camera to create album names on your computer. The next time you connect the camera to the computer, copy up to 32 albums to the album name list. See EasyShare software Help for details.

### Second—on your camera

- 1 In any mode, press the Menu button.
- 2 Press  $\blacktriangle/\blacktriangledown$  to highlight Set Album , then press the OK button.
- 3 Press  $\blacktriangle/\blacktriangledown$  to highlight an album name, then press the OK button. Repeat to mark pictures or videos for albums.

*Selected albums are noted with a check mark.*

- 4 To remove a selection, highlight an album name and press the OK button. To remove all album selections, select Clear All.
- 5 Highlight Exit, then press the OK button.

*Your selections are saved. If you turn on the LCD, your album selection is displayed on the screen. A plus (+) after the album name means more than one album is selected.*

- 6 Press the Menu button to exit the menu.

### Third—transfer to your computer

When you transfer the tagged pictures or videos to your computer, EasyShare software opens and categorizes your pictures in the appropriate album. See EasyShare software Help for details.

## Tagging pictures/videos for albums

Use the Album feature in Review mode to tag the pictures/videos in your camera with album names.

### First—on your computer

Use EasyShare software to create albums on your computer, then copy up to 32 album names to the camera's internal memory. See EasyShare software Help for details.

### Second—on your camera

- 1 Press the Review button, then locate the picture or video.
- 2 Press the Menu button.
- 3 Press  $\blacktriangle/\blacktriangledown$  to highlight Album , then press the OK button.
- 4 Press  $\blacktriangle/\blacktriangledown$  to highlight an album folder, then press the OK button.

To add other pictures to the same album, press  $\blacktriangle/\blacktriangleright$  to scroll through the pictures. When the picture you want is displayed, press the OK button.

To add the pictures to more than one album, repeat step 4 for each album.

*The album name appears with the picture. A plus (+) after the album name means the picture was added to more than one album.*

To remove a selection, highlight an album name and press the OK button. To remove all album selections, select Clear All.

### Third—transfer to your computer



When you transfer the tagged pictures/videos to your computer, EasyShare software opens and categorizes your pictures/videos in the appropriate album folder. See EasyShare software Help for details.

## Sharing your pictures

Press the Share button to “tag” your pictures and videos. When they are transferred to your computer, you can share them. Use the Share button:

- Any time. (The most recent picture/video taken is then displayed.)
- Just after you take a picture/video, during quickview.
- After pressing the Review button.

## Tagging pictures for printing

- 1 Press the Share button. Press ◀/▶ to locate a picture.
  - 2 Press ▲/▼ to highlight Print , then press the OK button.\*
  - 3 Press ▲/▼ to select the number of copies (0-99).  
**Optional:** You can apply a print quantity to other pictures. Press ◀/▶ to locate another picture. Press ▲/▼ to change the print quantity.
  - 4 Press the OK button.  
*The Print icon  appears in the status area.*
  - 5 Press the Share button to exit the menu.
- \* To tag all pictures in the storage location, highlight Print All, press the OK button, then indicate the number of copies. Print All is not available in quickview. To remove print tagging for all pictures in the storage location, highlight Cancel Prints, then press the OK button. Cancel Prints is not available in quickview.

## Printing tagged pictures

When you transfer the tagged pictures to your computer, Kodak EasyShare software print screen opens. See EasyShare software Help for details.

For more information on printing from your computer, printer dock, PictBridge enabled printer, or card, see [page 15](#).



NOTE: For the best 4 x 6 in. (10 x 15 cm) prints, set the camera to the 5 MP (3:2) picture size setting. (See [page 28](#).)

## Tagging pictures and videos for emailing

### First—on your computer

Use EasyShare software to create an email address book on your computer. Then copy up to 32 email addresses to the camera's internal memory. See EasyShare software Help for details.

### Second—tag pictures/videos on your camera

- 1 Press the Share button. Press ◀/▶ to locate a picture/video.
- 2 Press ▲/▼ to highlight Email , then press the OK button.  
*The Email icon  appears in the status area.*
- 3 Press ▲/▼ to highlight an email address, then press the OK button.

To tag other pictures/videos with the same address, press ◀/▶ to scroll through them. When the picture you want is displayed, press OK.

To send the pictures/videos to more than one address, repeat step 3 for each address.

*Selected addresses are checked.*

- 4 To remove a selection, highlight a checked address and press the OK button. To remove all email selections, highlight Clear All.
- 5 Press ▲/▼ to highlight Exit, then press the OK button.
- 6 Press the Share button to exit the menu.

### Third—transfer and email

When you transfer the tagged pictures/videos to your computer, the Email screen opens and lets you send them to the addresses you specified. See EasyShare software Help for details.

## Tagging pictures as favorites

You can preserve your favorite pictures in the Favorites section of your camera's internal memory, then share them with friends and family.

NOTE: When you transfer pictures from your camera to your computer, all pictures (including favorites) are stored on your computer at full size. Favorite pictures - smaller copies of your originals - are loaded back to your camera, so you can share and enjoy more.

<b>1. Tag pictures as favorites</b>	<ol style="list-style-type: none"><li>1 Press the Share button. Press   to locate a picture.</li><li>2 Press   to highlight Favorite , then press the OK button. <i>The Favorite icon  appears in the status area. To remove the tag, press the OK button again. Press the Share button to exit the menu.</i></li></ol>
<b>2. Transfer pictures to your computer</b>	<ol style="list-style-type: none"><li>1 To enjoy full functionality, load and use the EasyShare software that was packaged with this camera. (See <a href="#">page 13</a>.)</li><li>2 Connect the camera to the computer using the USB cable (see <a href="#">page 14</a>) or an EasyShare dock. <i>The first time you transfer pictures, the software helps you make choices about your favorite pictures. Then, your pictures are transferred to the computer. Favorite pictures (smaller versions of the originals) are loaded to the Favorites section of your camera's internal memory.</i></li></ol>
<b>3. View favorites on your camera</b>	<ol style="list-style-type: none"><li>1 Turn the Mode dial to Favorites .</li><li>2 Press   to scroll through favorites.</li></ol>

NOTE: The camera holds a limited number of favorites. Use Camera Favorites in the EasyShare software to customize the size of your camera Favorites section. Videos tagged as favorites remain in the Favorites folder in EasyShare software. See EasyShare software Help for details.

## Optional settings



In Favorites mode, press the Menu button to access optional settings.

Slide Show ( <a href="#">page 34</a> )	Remove all favorites ( <a href="#">page 43</a> )
Multi-up ( <a href="#">page 10</a> )	Setup Menu ( <a href="#">page 31</a> )

NOTE: Pictures taken at the 5 MP (3:2) quality setting are displayed at a 3:2 aspect ratio with a black bar at the top of the screen.



## Removing all favorites from your camera





- 1 Turn the Mode dial to Favorites .
- 2 Press the Menu button.
- 3 Highlight Remove Favorites , then press the OK button.  
*All pictures stored in the Favorites section of internal memory are removed. Favorites are restored the next time you transfer pictures to the computer.*
- 4 Press the Menu button to exit the menu.

## Preventing favorites from transferring to the camera

- 1 Open Kodak EasyShare software. Click the My Collection tab.
- 2 Go to the Albums view.
- 3 Click the Camera Favorites Album for your camera.
- 4 Click Remove Album.

*The next time you transfer pictures from your camera to the computer, use the Camera Favorites Wizard/Assistant to either recreate your Camera Favorites Album or to turn off the Camera Favorites feature.*

## Printing and emailing favorites

- 1 Turn the Mode dial to Favorites . Press / to locate a picture.
- 2 Press the Share button.
- 3 Highlight Print  or Email , then press the OK button.

NOTE: Favorites that were taken on this camera (not imported from another source) are good for prints up to 4 x 6 in. (10 x 15 cm).

## 5

# Troubleshooting

For step-by-step product support, visit [www.kodak.com/go/c663support](http://www.kodak.com/go/c663support) and select Interactive Troubleshooting & Repairs.

## Camera problems

Status	Solution
Camera does not turn on	<ul style="list-style-type: none"> <li>■ Remove battery and verify that it's the correct type, then reinsert it.</li> <li>■ Insert a new or charged battery.</li> </ul>
Camera does not turn off and the lens does not retract	<ul style="list-style-type: none"> <li>■ Connect the camera to a Kodak 3-volt AC adapter (sold separately), then try again. See <a href="#">page 57</a> for more battery information.</li> </ul>
Camera buttons and controls do not function	
Lens does not extend when camera turns on or does not retract	<ul style="list-style-type: none"> <li>■ Confirm that the battery in camera is charged.</li> <li>■ Turn camera off, then on again. (Lens does not extend in Favorites mode.)</li> <li>■ If problem still exists, get help (<a href="#">page 49</a>).</li> </ul>
LCD is black or does not turn on	<ul style="list-style-type: none"> <li>■ Push the LCD button to change the display.</li> </ul>
In Review, a blue or black screen is displayed instead of a picture	<ul style="list-style-type: none"> <li>■ Transfer the picture to the computer.</li> <li>■ Transfer <i>all</i> pictures to the computer (<a href="#">page 14</a>).</li> <li>■ Take another picture. If problem continues, try internal memory and/or another memory card.</li> </ul>
Picture orientation is not accurate	<ul style="list-style-type: none"> <li>■ Set the Orientation Sensor to ON (see <a href="#">page 33</a>).</li> </ul>

Status	Solution
Pictures remaining number does not decrease after taking a picture	<ul style="list-style-type: none"> <li>■ Continue taking pictures. The camera is operating normally. (The camera estimates the number of pictures remaining after each picture is taken, based on picture size and content.)</li> </ul>
Flash does not fire	<ul style="list-style-type: none"> <li>■ Check the flash setting and change as needed (page 20).</li> </ul> <p>NOTE: The flash does not fire in all modes.</p>
Storage location is almost or entirely full	<ul style="list-style-type: none"> <li>■ Transfer pictures to the computer (page 14). Delete pictures from the card (page 12) or insert a new card.</li> <li>■ Change image storage location to internal memory (page 31).</li> </ul>
Battery life is short	<ul style="list-style-type: none"> <li>■ Make sure the correct battery type is installed (page 2).</li> <li>■ Wipe the contacts with a clean, dry cloth before inserting a battery in the camera.</li> <li>■ Insert a new or charged battery.</li> </ul>
You cannot take a picture	<ul style="list-style-type: none"> <li>■ Turn the camera off, then on again. Make sure the camera is not in Favorites mode.</li> <li>■ Depress shutter button all the way (page 6).</li> <li>■ Insert a new or charged battery (page 2).</li> <li>■ Wait until the Ready light turns green before attempting to take another picture.</li> <li>■ Memory full. Transfer pictures to the computer (page 14), delete pictures (page 12), change image storage location (page 31), or insert another card.</li> </ul>
Error message appears on LCD	<ul style="list-style-type: none"> <li>■ Turn the camera off, then on again.</li> <li>■ Remove memory card from the camera.</li> <li>■ Remove the battery and wipe the contacts with a clean, dry cloth.</li> <li>■ Insert a new or charged battery (page 2).</li> <li>■ If problem still exists, get help (page 49).</li> </ul>

Status	Solution
Memory card not recognized or camera freezes with card.	<ul style="list-style-type: none"> <li>■ Card may be corrupted. Format card in camera (see <a href="#">page 33</a>).</li> <li>■ Use another memory card.</li> </ul>

## Computer/connectivity problems

Status	Solution
Computer does not communicate with the camera	<ul style="list-style-type: none"> <li>■ Insert a charged battery (<a href="#">page 2</a>).</li> <li>■ Turn on the camera.</li> <li>■ Make sure the proper USB cable is connected on camera and computer port (<a href="#">page 14</a>). (If using an EasyShare dock, check all cable connections. Make sure the camera is seated on the dock.)</li> <li>■ Make sure the EasyShare software is installed (<a href="#">page 13</a>).</li> </ul>
Pictures do not transfer to computer	<ul style="list-style-type: none"> <li>■ See EasyShare software Help for details.</li> </ul>
Slide Show does not run on an external video device	<ul style="list-style-type: none"> <li>■ Adjust the camera Video Out setting (see <a href="#">page 32</a>).</li> <li>■ Make sure the external device settings are correct (see the device's user's guide).</li> </ul>

## Picture quality problems

Status	Solution
Picture is not clear	<ul style="list-style-type: none"> <li>■ To automatically set exposure and focus, press the Shutter button <b>halfway</b>. When the Ready light turns green, press the Shutter button <b>completely down</b> to take the picture.</li> <li>■ Clean the lens (<a href="#">page 58</a>).</li> <li>■ Make sure camera is not in Close-up mode if you are more than 21 in. (0.7 m) from your subject.</li> <li>■ Place the camera on a flat, steady surface or use a tripod, especially in high-zoom settings or in low light.</li> </ul>

Status	Solution
Picture is too dark	<ul style="list-style-type: none"> <li>■ Reposition camera for more available light.</li> <li>■ Use Fill flash (<a href="#">page 20</a>) or change your position so light is not behind the subject.</li> <li>■ Move so that the distance between you and the subject is within the effective flash range (<a href="#">page 52</a>).</li> <li>■ To automatically set exposure and focus, press the Shutter button <b>halfway</b>. When the Ready light turns green, press the Shutter button completely down to take the picture.</li> <li>■ Adjust exposure compensation (<a href="#">page 23</a>).</li> </ul>
Picture is too light	<ul style="list-style-type: none"> <li>■ Reposition the camera to reduce the amount of available light.</li> <li>■ Turn off the flash (<a href="#">page 20</a>).</li> <li>■ Move so that the distance between you and the subject is within the effective flash range (<a href="#">page 52</a>).</li> <li>■ To automatically set exposure and focus, press the Shutter button <b>halfway</b>. When the Ready light turns green, press the Shutter button <b>completely down</b> to take the picture.</li> <li>■ Adjust exposure compensation (<a href="#">page 23</a>).</li> </ul>

## Direct printing (PictBridge enabled printer) problems

Status	Solution
Cannot locate desired picture.	<ul style="list-style-type: none"><li>■ Turn on the camera.</li><li>■ Use the Direct print menu to change the image storage location.</li></ul>
The Direct print menu interface turns off.	<ul style="list-style-type: none"><li>■ Press any button to redisplay the menu.</li></ul>
Cannot print pictures.	<ul style="list-style-type: none"><li>■ Ensure that there is a connection between the camera and the printer.</li><li>■ Ensure the printer and camera have power.</li></ul>
Camera or printer display an error message.	<ul style="list-style-type: none"><li>■ Follow the prompts to resolve the issue.</li></ul>

# 6

## Getting help

### Helpful links

#### Camera

Get support for your product (FAQs, troubleshooting information, arrange for repairs, etc.)	<a href="http://www.kodak.com/go/C663support">www.kodak.com/go/C663support</a>
Purchase camera accessories (camera docks, printer docks, lenses, cards, etc.)	<a href="http://www.kodak.com/go/C663accessories">www.kodak.com/go/C663accessories</a>
Download the latest camera firmware and software	<a href="http://www.kodak.com/go/C663downloads">www.kodak.com/go/C663downloads</a>
See online demonstrations of your camera	<a href="http://www.kodak.com/go/howto">www.kodak.com/go/howto</a>

#### Software

Get information on EasyShare software	<a href="http://www.kodak.com/go/easysharesw">www.kodak.com/go/easysharesw</a> (or click the Help button in EasyShare software)
Get help with the Windows operating system and working with digital pictures	<a href="http://www.kodak.com/go/pcbasics">www.kodak.com/go/pcbasics</a>

#### Other

Get support for other cameras, software, accessories	<a href="http://www.kodak.com/go/support">www.kodak.com/go/support</a>
Get information on Kodak EasyShare printer docks	<a href="http://www.kodak.com/go/printerdocks">www.kodak.com/go/printerdocks</a>
Get information on Kodak inkjet products	<a href="http://www.kodak.com/go/inkjet">www.kodak.com/go/inkjet</a>
Optimize your printer for truer, more vibrant colors	<a href="http://www.kodak.com/go/onetouch">www.kodak.com/go/onetouch</a>
Register your camera	<a href="http://www.kodak.com/go/register">www.kodak.com/go/register</a>

## Telephone customer support

If you have questions concerning this product, you may speak with a customer support representative:

Australia	1800 147 701
Austria	0179 567 357
Belgium	02 713 14 45
Brazil	0800 150000
Canada	1 800 465 6325
China	800 820 6027
Denmark	3 848 71 30
Ireland	01 407 3054
Finland	0800 1 17056
France	01 55 1740 77
Germany	069 5007 0035
Greece	00800 44140775
Hong Kong	800 901 514
India	91 22 617 5823
Italy	02 696 33452
Japan	03 5540 9002
Korea	00798 631 0024

Netherlands	020 346 9372
New Zealand	0800 440 786
Norway	23 16 21 33
Philippines	1 800 1 888 9600
Poland	00800 4411625
Portugal	021 415 4125
Singapore	800 6363 036
Spain	91 749 76 53
Sweden	08 587 704 21
Switzerland	01 838 53 51
Taiwan	0800 096 868
Thailand	001 800 631 0017
Turkey	00800 448827073
United Kingdom	0870 243 0270
United States	1 800 235 6325
Outside the US	585 726 7260
International Toll Line	+44 131 458 6714
International Toll Fax	+44 131 458 6962

For the most up-to-date listings, visit:

[www.kodak.com/US/en/digital/contacts/DAInternationalContacts.shtml](http://www.kodak.com/US/en/digital/contacts/DAInternationalContacts.shtml)



## Camera specifications

For more specifications, visit [www.kodak.com/go/C663support](http://www.kodak.com/go/C663support).

**CCD**—1/2.5 in. CCD, 4:3 aspect ratio

### Output image size—

6 MP: 2832 x 2128 pixels

5 MP (3:2): 2832 x 1888 pixels

4 MP: 2304 x 1728 pixels

3 MP: 2048 x 1536 pixels

1 MP: 1200 x 900 pixels

**Color display**—2.5 in. (5.6 cm) color hybrid LCD; 115 K pixels

**Color electronic viewfinder**—LCD

**Preview (LCD)**—Frame rate: 30 fps

**Taking lens**—3X optical zoom, aspheric all-glass Schneider-Kreuznach Variogon lens, f/2.7-4.6 (35 mm equivalent: 34-102 mm)

**Lens protection**—Built-in

**Digital zoom**—Combined zoom settings 3.6 to 15X in 0.6X increments. (Not supported for movie capture.)

**Focus system**—TTL-AF; auto, center-zone. Working range:

24 in. (0.6 m)-infinity @ wide

6.6 ft (2 m)-infinity @ telephoto

2-27.6 in. (0.05-0.7 m) @ wide close-up

8.7-27.6 in. (0.22-0.7 m) @ telephoto close-up

32.8 ft (10 m)-infinity @ Landscape

**Exposure metering**—TTL-AE; Multi-pattern, Center-spot, Center-weighted

**Exposure compensation**—+/-2.0 EV with 1/3 EV step

**Shutter speed**—

Auto: 1/8-1/1600 sec.

Long time exposure: 0.5-8 sec.

**ISO speed**—

Auto: 80-160

Selectable: 80, 100, 200, 400, 800 (800 available only in 1 MP picture size)

**Electronic flash**—Auto flash with photo sensor

Working range @ ISO 140: 2-12.1 ft (0.6-3.7 m) @ Wide; 2-6.9 ft (0.6-2.1 m) @ Tele

**Flash modes**—Auto, Fill, Red Eye, Off

**Capture modes**—Auto, Landscape, Close-up, P/M modes, Video, Scene modes

**Burst mode**—Maximum 4 pictures (3 pictures at ISO 400 or 800); AE, AF, AWB executed for first shot only

**Video capture**—

VGA (640 x 480) @ 24 fps

QVGA (320 x 240) @ 24 fps

**Image file format**—

Still: EXIF 2.21 (JPEG compression); file organization DCF

Video: QuickTime (CODEC MPEG-4)

**Image storage**—Optional MMC or SD Card  (The SD logo is a trademark of the SD Card Association.)

**Internal storage capacity**—32 MB internal memory (28 MB available for image storage. 1 MB equals one million bytes.)

**Quickview**—Yes

**Video output**—NTSC or PAL

**Power**—CRV3; 2-AA lithium; 2-AA Ni-MH; Kodak Ni-MH rechargeable digital camera battery (KAA2HR); 3V AC adapter

**Communication with computer**—USB 2.0 (PIMA 15740 protocol), via USB cable (U-8), EasyShare camera dock or printer dock

**PictBridge printer support**—Yes

**Self-timer**—2 seconds, 10 seconds, or 2-shot

**White balance**—Auto, Daylight, Open Shade, Tungsten, Fluorescent

**Color modes**—High, Natural, Low, Black & White, Sepia

**Date stamp**—None, YYYYMMDD, MMDDYYYY, DDMMYYYY

**Tripod mount**—1/4 inch

**Viewfinder**—Optical, real-image; 84% field of view

**Operating temperature**—32–104° F (0–40° C)

**Size**—1.4 in. (3.55 cm) x 2.5 in. (6.47 cm) x 3.3 in. (8.47 cm) @ power off

**Weight**—5.3 oz (150 g) without card or battery

## Flash settings in each mode

Flash settings are pre-set for each picture-taking mode.

Capture mode	Default setting	Available settings
<b>Auto</b>	Auto*	Auto, Off, Fill Flash, Red Eye
<b>Landscape</b>	Off	Off
<b>Close-up</b>	Off	Auto, Off, Fill Flash
<b>Video</b>	Off	Off
<b>First burst, Last burst</b>	Off	Off
<b>P (Program)</b>	Auto*	Auto, Off, Fill Flash, Red Eye
<b>M (Manual)</b>	Fill Flash	Off, Fill Flash, Red Eye
<b>SCN: Portrait</b>	Auto*	Auto, Off, Fill Flash, Red Eye
<b>SCN: Sport</b>	Auto*	Auto, Off, Fill Flash, Red Eye
<b>SCN: Children</b>	Auto*	Auto, Off, Fill Flash, Red Eye
<b>SCN: Party</b>	Red Eye*	Auto, Off, Fill Flash, Red Eye
<b>SCN: Beach</b>	Auto*	Auto, Off, Fill Flash, Red Eye
<b>SCN: Snow</b>	Auto*	Auto, Off, Fill Flash, Red Eye
<b>SCN: Fireworks</b>	Off	Off
<b>SCN: Flower</b>	Off	Off, Fill Flash
<b>SCN: Self-Portrait</b>	Red Eye*	Auto, Off, Fill Flash, Red Eye
<b>SCN: Backlight</b>	Fill Flash	Fill Flash
<b>SCN: Night Portrait</b>	Red Eye*	Auto, Off, Fill Flash, Red Eye
<b>SCN: Night Landscape</b>	Off	Off
<b>SCN: Manner/Museum</b>	Off	Off
<b>SCN: Text</b>	Off	Off, Fill Flash

\* When you change to Auto or Red Eye in these modes, it becomes the default.

## Storage capacities

File sizes vary. You may be able to store more or fewer pictures and videos. Favorites take up additional space in internal memory.

### Picture storage capacity

	Number of pictures				
	6 MP	5 MP (3:2)	4 MP	3 MP	1 MP
<b>Internal memory</b>	14	16	21	27	65
<b>32 MB SD/MMC</b>	16	18	24	30	73
<b>64 MB SD/MMC</b>	33	37	48	60	146
<b>128 MB SD/MMC</b>	66	74	97	121	293
<b>256 MB SD/MMC</b>	133	149	196	242	588
<b>512 MB SD/MMC</b>	266	298	392	485	1176

### Video storage capacity

	Minutes/seconds of video	
	VGA (640 x 480)	QVGA (320 x 240)
<b>Internal memory</b>	1 min. 10 sec.	3 min. 23 sec.
<b>32 MB SD/MMC</b>	1 min. 15 sec.	3 min. 46 sec.
<b>64 MB SD/MMC</b>	2 min. 30 sec.	7 min. 32 sec.
<b>128 MB SD/MMC</b>	5 min.	15 min. 4 sec.
<b>256 MB SD/MMC</b>	10 min.	30 min. 8 sec.
<b>512 MB SD/MMC</b>	20 min.	60 min. 17 sec.

## Important safety instructions



### CAUTION:

**Do not disassemble this product; there are no user-serviceable parts inside. Refer servicing to qualified service personnel. Do not expose this product to liquid, moisture, or extreme temperatures. Kodak AC adapters and battery chargers are intended for indoor use only. The use of controls, adjustments, or procedures other than those specified herein may result in exposure to shock and/or electrical or mechanical hazards. If the LCD breaks, do not touch the glass or liquid. Contact Kodak customer support.**

## Using this product

- The use of an accessory attachment that is not recommended by Kodak, such as an AC adapter, may cause fire, electric shock, or injury.
- Use only a USB-certified computer. Contact your computer manufacturer if you have questions.
- If using this product in an airplane, observe all instructions of the airline.

## Battery safety and handling



### CAUTION:

**When removing the battery, allow it to cool; it may be hot.**

- Use only batteries approved for this product to avoid risk of explosion.
- Keep batteries out of the reach of children.
- Do not allow batteries to touch metal objects, including coins. Otherwise, a battery may short circuit, discharge energy, become hot, or leak.
- Do not disassemble, install backward, or expose batteries to liquid, moisture, fire, or extreme temperature.

- Remove the battery when the product is stored for an extended period of time. In the unlikely event that battery fluid leaks inside the product, contact Kodak customer support.
- In the unlikely event that battery fluid leaks onto your skin, wash immediately with water and contact your local health provider. For additional health-related information, contact your local Kodak customer support.
- Dispose of batteries according to local and national regulations.
- Do not charge non-rechargeable batteries.

For more information on batteries, see

[www.kodak.com/global/en/service/batteries/batteryUsage.jhtml](http://www.kodak.com/global/en/service/batteries/batteryUsage.jhtml)

## Battery life

Use these Kodak batteries. (Battery types are also molded into the battery door.)

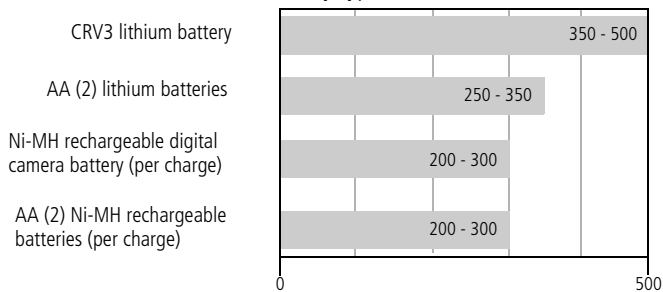

Battery life per CIPA testing method (Approx. number of pictures in Auto mode, using 128 MB SD card.). Actual life may vary based on usage.

**We do not recommend or support alkaline batteries.** For acceptable battery life, and to make sure your camera operates dependably, use the batteries listed.

## Extending battery life

- See LCD Brightness ([page 32](#)) and Auto Power Off ([page 32](#)).
- Limit the following activities that quickly deplete battery power:
  - Reviewing your pictures on the LCD (see [page 10](#))
  - Using the LCD as a viewfinder (see [page 6](#))
  - Excessive use of the flash
- Dirt on the battery contacts can affect battery life. Wipe the contacts with a clean, dry cloth before loading batteries in the camera.
- Battery performance is reduced at temperatures below 41° F (5° C). When using your camera in cold weather, carry spare batteries and keep them warm. Do not discard cold batteries that do not work; when they return to room temperature, they may be usable.

## Upgrading your software and firmware

Download the latest versions of the software included on the Kodak EasyShare software CD and the camera firmware (the software that runs on the camera). See [www.kodak.com/go/C663downloads](http://www.kodak.com/go/C663downloads).

## Additional care and maintenance

- If the camera has been subjected to inclement weather or you suspect water has gotten inside the camera, turn off the camera and remove the battery and card. Allow all components to air-dry for at least 24 hours before using the camera again.
- Blow gently on the lens or LCD to remove dust and dirt. Wipe gently with a soft, lint-free cloth or an untreated lens-cleaning tissue. Do not use cleaning solutions unless designed specifically for camera lenses. Do not allow chemicals, such as suntan lotion, to contact painted surfaces.



- Service agreements may be available in your country. Contact a dealer of Kodak products for more information.
- For digital camera disposal or recycling information, contact your local authorities. In the US, visit the Electronics Industry Alliance Web site at [www.eiae.org](http://www.eiae.org) or the Kodak Web site at [www.kodak.com/go/C663support](http://www.kodak.com/go/C663support).

## Warranty

### Limited warranty

Kodak warrants Kodak EasyShare digital cameras and accessories (excluding batteries) to be free from malfunctions and defects in both materials and workmanship for one year from the date of purchase.

Retain the original dated sales receipt. Proof of the date of purchase will be required with any request for warranty repair.

### Limited warranty coverage

This limited warranty will be honored only within the geographical location that Kodak digital cameras and accessories were purchased.

Kodak will REPAIR or REPLACE Kodak EasyShare digital cameras and accessories if they fail to function properly during the warranty period, subject to any conditions and/or limitations stated herein. Such repair service will include all labor as well as any necessary adjustments and/or replacement parts. Such repair or replacement is the sole remedy under this warranty.

If replacement parts are used in making repairs, these parts may be remanufactured, or may contain remanufactured materials. If it is necessary to replace the entire product, it may be replaced with a remanufactured product.

### Limitations

Request for Warranty service will not be accepted without proof of date of purchase, such as a copy of the original dated Kodak EasyShare digital camera or accessory sales receipt. (Always keep the original for your records.)

This warranty does not apply to the battery(s) used in digital cameras or accessories. This warranty does not cover circumstances beyond Kodak's control, nor problems caused by failure to follow the operating instructions in the Kodak EasyShare digital cameras and accessories User's Guides.

This warranty does not apply when failure is due to shipping damage, accident, alteration, modification, unauthorized service, misuse, abuse, use with incompatible accessories or attachments, failure to follow Kodak's operation, maintenance or repacking instructions, failure to use items supplied by Kodak (such as adapters and cables), or claims made after the duration of this warranty.

Kodak makes no other express or implied warranty for this product. In the event that the exclusion of any implied warranty is ineffective under the law, the duration of the implied warranty will be one year from the purchase date.

The option of replacement is Kodak's only obligation. Kodak will not be responsible for any special, consequential or incidental damages resulting from the sale, purchase, or use of this product, regardless of the cause. Liability for any special, consequential or incidental damages (including but not limited to loss of revenue or profit, downtime costs, loss of the use of the equipment, cost of substitute equipment, facilities or services, or claims of your customers for such damages resulting from the purchase, use or failure of the product), regardless of cause or for breach of any written or implied warranty is expressly disclaimed and excluded herefrom.

## Your rights

Some states or jurisdictions do not allow exclusion or limitation of incidental or consequential damages, so the above limitation or exclusion may not apply to you. Some states or jurisdictions do not allow limitations on how long an implied warranty lasts, so the above limitation may not apply to you.

This warranty gives you specific rights, and you may have other rights which vary from state to state or by jurisdiction.

## Outside the United States and Canada

In countries other than the United States and Canada, the terms and conditions of this warranty may be different. Unless specific Kodak warranty is communicated to the purchaser in writing by a Kodak company, no warranty or liability exists beyond any minimum requirements imposed by law, even though defect, damage, or loss may be by negligence or other act.

## Regulatory compliance

### FCC compliance and advisory

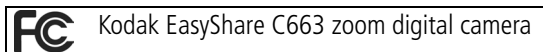

This equipment has been tested and found to comply with the limits for a Class B digital device, pursuant to Part 15 of the FCC Rules. These limits are designed to provide reasonable protection against harmful interference in a residential installation.

This equipment generates, uses, and can radiate radio frequency energy and, if not installed or used in accordance with the instructions, may cause harmful interference to radio communications. However, there is no guarantee that interference will not occur in a particular installation.

If this equipment does cause harmful interference to radio or television reception, which can be determined by turning the equipment off and on, the user is encouraged to try to correct the interference by one or more of the following measures: 1) reorient or relocate the receiving antenna; 2) increase the separation between the equipment and the receiver; 3) connect the equipment to an outlet on a circuit different from that to which the receiver is connected; 4) consult the dealer or an experienced radio/TV technician for additional suggestions.

Any changes or modifications not expressly approved by the party responsible for compliance could void the user's authority to operate the equipment. Where shielded interface cables have been provided with the product or specified additional components or accessories elsewhere defined to be used with the installation of the product, they must be used in order to ensure compliance with FCC regulation.

## Australian C-Tick



## Canadian DOC statement

**DOC Class B Compliance**—This Class B digital apparatus complies with Canadian ICES-003.

**Observation des normes-Class B**—Cet appareil numérique de la classe B est conforme à la norme NMB-003 du Canada.

## Waste Electrical and Electronic Equipment labeling



In the European Union, do not discard this product as unsorted municipal waste. Contact your local authorities or go to [www.kodak.com/go/recycle](http://www.kodak.com/go/recycle) for recycling program information.

## VCCI Class B ITE

この装置は、情報処理装置等電波障害自主規制協議会（VCCI）の基準に基づくクラスB情報技術装置です。この装置は、家庭環境で使用することを目的としていますが、この装置がラジオやテレビジョン受信機に近接して使用されると、受信障害を引き起こすことがあります。  
取扱説明書に従って正しい取り扱いをして下さい。

English translation: This is a Class B product based on the standard of the Voluntary Control Council for Interference from Information Technology Equipment (VCCI). If this is used near a radio or television receiver in a domestic environment, it may cause radio interference. Install and use the equipment according to the instruction manual.

## MPEG-4

Use of this product in any manner that complies with the MPEG-4 visual standard is prohibited, except for use by a consumer engaging in personal and non-commercial activities.

---

# Index

## A

- A/V out, 35
- about picture, video, 37
- about this camera, 33
- accessories, 14
  - battery, 58
  - buying, 49
  - printer dock, 15
  - SD/MMC card, 5
- album
  - set, 30
  - tagging pictures, 38
- appendix, 51
- auto
  - enhancement, 35
  - flash, 20
  - focus control, 30
  - focus framing marks, 9
  - mode, 21

## B

- backlight, 22
- battery
  - compartment, ii
  - expected life, 57
  - extending life, 58
  - life, 57
  - loading, 2
  - safety, 56
  - types, 57
- beach, 22
- blur, 7

- blur warning, 33
- burst button, i
- burst, using, 27
- button
  - burst, i, 27
  - delete, ii, 7
  - flash, 20
  - flash, flash button, i
  - info, ii
  - LCD/Info, ii
  - menu, ii
  - OK, ii
  - review, ii, 10
  - self-timer, self-timer button, i
  - Share, ii
  - shutter, i
  - telephoto, ii
  - wide angle, ii
  - zoom, 19

## C

- cable
  - audio/video, 35
  - USB, 14
- camera screen
  - reviewing videos, 10
- camera sounds, 32
- caring for your camera, 58
- caution
  - formatting, 12
- children, 22
- clock, setting, 4

color mode, 30  
compatibility, dock, 18  
copy pictures  
    card to memory, 37  
    memory to card, 37  
    to computer, 13  
cropping pictures, 36  
CRV3 battery, loading, 3  
customer support, 50  
customizing camera, 31

## D

date setting, 4  
date stamp, 33  
DC-in, i  
delete button, ii  
deleting  
    during quickview, 7  
    pictures, videos, 12  
    protecting pictures, videos, 12  
displaying slide show, 34  
disposal, recycling, 59, 62  
dock  
    compatibility, 18  
    connector, ii  
    printer, 15  
download pictures, 13

## E

EasyShare software  
    installing, 13  
emailing pictures, videos, 41  
expected battery life, 57  
exposure

    compensation, 23  
    metering, 29  
exposure bracketing, 28  
exposure compensation, 28  
external video device  
    viewing pictures, videos, 35

## F

favorites  
    removing, 43  
    settings, 42  
    tagging, 42  
fill flash, 20  
fireworks, 22  
firmware, upgrading, 58  
flash  
    settings in each mode, 54  
flash off, 20  
flash settings, 20  
flower, 22  
focus  
    framing marks, 9  
    zone, 29  
format, 33  
formatting  
    caution, 12

## G

guidelines, battery, 58

## H

help, 44  
    web links, 49  
histogram, 23

**I**

icon

blur, 7

icons

picture-taking, 8

reviewing pictures, 11

icons, mode dial, 21

image storage, 31

info button, ii

information

about pictures, videos, 37

installing

battery, 2

SD/MMC card, 5

software, 13

internal memory

storage capacity, 55

interval, slide show, 34

**K**

Kodak EasyShare software

upgrading, 58

Kodak Perfect Touch technology, 35

Kodak web sites, 49

**L**

LCD, ii

LCD/Info button, ii

lens, i

cleaning lens, 58

light sensor, i

liveview, 32

loading

batteries, 2

SD/MMC card, 5

software, 13

loop, slide show, 34

**M**

Macintosh, installing software on, 13

magnify picture, 10

maintenance, camera, 58

manner, 22

manual, 24

memory

inserting card, 5

storage capacities, 55

menu button, ii

microphone, i

mode dial, i, 21

modes

auto, 21

backlight, 22

beach, 22

children, 22

fireworks, 22

flower, 22

manner, 22

manual, 24

night landscape, 22

night portrait, 22

party, 22

program, 24

SCN, 21

self-portrait, 22

snow, 22

text, 22

multi-up, 10

## N

night landscape, 22  
night portrait, 22

## O

OK button, ii  
online prints, ordering, 17  
optical zoom, 19  
orientation sensor, 33

## P

P/M mode  
    screen options, 24  
party, 22  
Perfect Touch technology, 35  
PictBridge enabled printer, 15  
picture  
    magnify, 10  
picture size, 28  
pictures  
    copying, 37  
    cropping, 36  
    deleting, 12  
    emailing tagged, 41  
    Kodak Perfect Touch, 35  
    printing, 16  
    protecting, 12  
    reviewing, 10  
    storage capacity, 55  
    tagging, 38  
    taking, modes, 21  
    transfer, 13  
picture-taking settings, 28  
power

    camera, 3  
    power light, i  
    printer dock, 15  
    printing  
        from a card, 17  
        from computer, 16  
        optimizing printer, 49  
        order online, 17  
        PictBridge technology, 15  
        tagged pictures, 17  
        with EasyShare printer dock, 15  
    problem-solving, 44  
    program, 24  
    protecting pictures, videos, 12

## Q

quickview  
    using, 7

## R

ready light, ii  
recycling, disposal, 59, 62  
red eye flash, 20  
regulatory information, 61  
removing favorites, 43  
repair, 49  
return, 31  
review button, ii, 10  
reviewing pictures  
    as you take them, 7  
    camera screen, 10  
reviewing pictures, videos  
    slide show, 34  
reviewing videos



camera screen, 10  
running slide show, 34

## S

safety, battery, 56  
scene modes, 22  
SCN, 21  
SD/MMC card  
    inserting, 5  
    printing from, 17  
    storage capacities, 55  
self-portrait, 22  
self-timer  
    with pictures, 26  
service and support telephone  
    numbers, 50  
setting  
    about, 33  
    album, 30  
    auto focus, 30  
    blur warning, 33  
    camera sounds, 32  
    color mode, 30  
    date and time, 4  
    date stamp, 33  
    exposure bracketing, 28  
    exposure compensation, 28  
    exposure metering, 29  
    focus zone, 29  
    image storage, 31  
    liveview, 32  
    orientation sensor, 33  
    picture size, 28  
    picture taking mode, 21

    return, 31  
    self-timer, 26  
    setup menu, 31  
    sharpness, 30  
    sound volume, 32  
    video date display, 33  
    video out, 32  
    video size, 31  
    white balance, 29  
settings  
    flash, 54  
    picture taking, 28  
setup menu, 31  
shaking hand, 7  
Share button, ii  
sharing pictures, videos, 40  
sharpness, 30  
shutter  
    problems, 45  
    self-timer delay, 26  
shutter button, i  
slide show  
    continuous loop, 34  
    interval, 34  
    problems, 46  
    running, 34  
snow, 22  
software  
    installing, 13  
    upgrading, 58  
sound volume, 32  
sounds, 32  
specifications, camera, 51  
status

blur, 7  
storage capacity, 55  
support, technical, 50

## T

tagging  
    favorites, 42  
    for albums, 38  
    for email, 41  
    for print, 40  
taking a picture, 6  
taking a video, 6  
telephone support, 50  
telephoto button, ii  
television, slide show, 35  
text, 22  
thumbnails, 10  
time, setting, 4  
timer, shutter delay, 26  
transferring pictures, videos, 13  
trash can, deleting, 7  
tripod socket, ii  
troubleshooting, 44  
turning camera on and off, 3

## U

undelete, 12  
undo, 12  
upgrading software, firmware, 58  
URLs, Kodak web sites, 49  
USB cable, 14  
USB, A/V out, ii  
using, 19

## V

VCCI compliance, 62  
video  
    action print, 36  
    copying, 37  
    date display, 33  
    out, 32  
    protecting, 12  
    reviewing, 10  
    storage capacities, 55  
    viewing, 10  
video size, 31  
videos  
    deleting, 12  
    emailing tagged, 41  
    transfer, 13  
viewfinder, i, ii  
viewing picture  
    after taking, 7, 10  
volume, 32

## W

warranty, 59  
WEEE, 62  
white balance, 29  
wide angle button, ii  
Windows OS-based computers  
    installing software, 13  
wrist strap, 1

## Z

zoom, using, 19