Kodak EasyShare Z730 zoom digital camera



User's guide

www.kodak.com

For interactive tutorials, www.kodak.com/go/howto

For help with your camera, www.kodak.com/go/z730support



Eastman Kodak Company

Rochester, New York 14650

© Eastman Kodak Company, 2005

All screen images are simulated.

Kodak and EasyShare are trademarks of Eastman Kodak Company.

P/N 4J3262

Top, front view

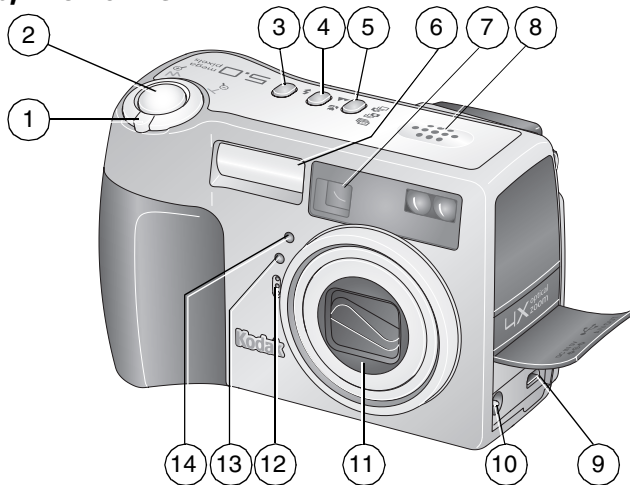

- | | |
|---|---|
| 1 Zoom (Wide angle/Telephoto);
Magnify (when Reviewing pictures) | 8 Speaker |
| 2 Shutter button | 9 USB Port  ; A/V Out, for
television viewing |
| 3 Flash status button | 10 DC-In (5V) |
| 4 Close-up/Landscape button | 11 Lens |
| 5 Exposure Bracketing/Burst button | 12 Microphone |
| 6 Flash unit | 13 Light sensor |
| 7 Viewfinder | 14 Self Timer/Video light |

Back, bottom view

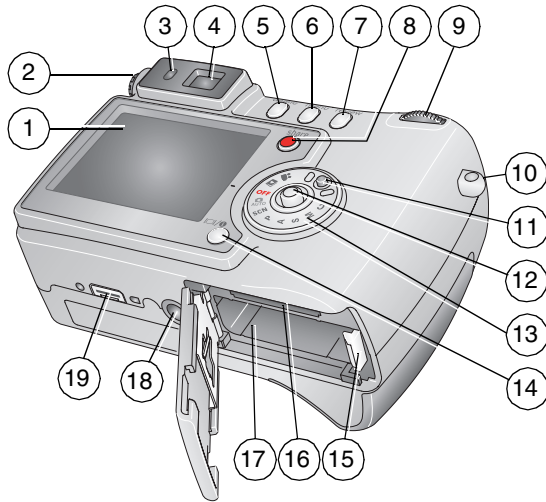

- | | | | |
|----|---------------------|----|---|
| 1 | Camera screen (LCD) | 11 | Mode dial lock |
| 2 | Diopter dial | 12 | Joystick - move  OK - press in |
| 3 | Ready light | 13 | Mode dial |
| 4 | Viewfinder | 14 | Display/Info button |
| 5 | Delete button | 15 | Battery lock |
| 6 | Menu button | 16 | MMC/SD card slot |
| 7 | Review button | 17 | Battery compartment |
| 8 | Share button | 18 | Tripod socket |
| 9 | Jog dial | 19 | Dock connector for EasyShare camera dock series 3 or printer dock series 3 |
| 10 | Strap post | | |

Table of contents

1 Getting started	1
Installing the software first	1
Charging the battery	1
Inserting the battery	2
Setting the date and time	2
Turning the camera on and off	3
Checking camera status in capture mode	4
Storing pictures on an optional SD or MMC card	5
Using optional lenses	5
2 Taking pictures and videos	6
Taking a picture	6
Taking a video	8
Reviewing the picture or video just taken	8
Using optical zoom	9
Using digital zoom	9
Camera modes	10
Using P, A, S, M, and C modes	13
Using the jog dial to change P, A, S, M, or C mode settings	14
Using the flash	15
Shooting close-up and landscape pictures	18
Using exposure bracketing	19
Using burst	20
Changing picture-taking settings	21
Using setup to customize your camera	27
Pre-tagging for album names	29

3	Reviewing pictures and videos	31
	Viewing single pictures and videos	31
	Viewing multiple pictures and videos	32
	Playing a video.....	32
	Deleting pictures and videos.....	33
	Magnifying pictures.....	33
	Changing optional review settings.....	34
	Protecting pictures and videos from deletion.....	34
	Tagging pictures/videos for albums.....	35
	Running a slide show	36
	Displaying pictures and videos on a television	37
	Copying pictures and videos	37
	Viewing picture/video information	38
4	Installing the software	39
	Install the software	39
5	Sharing pictures and videos	40
	When can I tag my pictures and videos?	40
	Tagging pictures for printing.....	41
	Tagging pictures and videos for emailing	42
	Tagging pictures as favorites	43
6	Transferring and printing pictures	46
	Transferring pictures/videos with the USB cable	46
	Printing pictures	47

7	Troubleshooting	50
	Camera problems	50
	Computer/connectivity problems	51
	Picture quality problems	52
	Camera ready light status	53
8	Getting help	54
	Helpful links	54
	Telephone customer support	55
9	Appendix	56
	Camera specifications	56
	Tips, safety, maintenance	59
	Important battery information	59
	Storage capacities	61
	Power-saving features	62
	Upgrading your software and firmware	62
	Warranty	63
	Regulatory compliance	65

1

Getting started

Installing the software first

IMPORTANT: *Install the software from the Kodak EasyShare software CD before connecting the camera (or dock) to the computer. Otherwise, the software may install incorrectly. See the Start Here! guide or [page 39](#).*

Charging the battery

The rechargeable Li-Ion battery requires charging before first use.

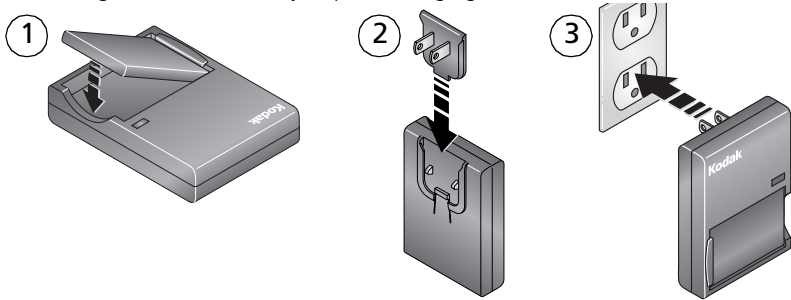

- 1 Insert the battery into the charger.
- 2 Insert the plug that matches your electrical outlet.
- 3 Plug the charger into the outlet.

The indicator light turns red. When the indicator light turns green, remove the battery and unplug the charger. Charging takes approximately 3 hours.

NOTE: You can also charge the battery using an optional Kodak EasyShare printer dock or camera dock. Purchase these and other accessories at a dealer of Kodak products or visit www.kodak.com/go/accessories.

Inserting the battery



CAUTION:

Use only a Kodak EasyShare rechargeable Li-Ion battery.



- 1 Turn the Mode dial to Off.
- 2 On the bottom of the camera, slide the battery door and lift to open.

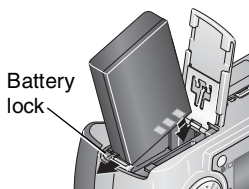

- 3 Insert the battery as shown. Tilt the battery so the battery lock is pushed to the side. Push the battery into the battery compartment.

The battery lock holds the battery in place.

- 4 Close the battery door.



Setting the date and time

Setting the date & time, first time

The *Date and Time have been reset* message appears the first time you turn on the camera or if the battery is removed for an extended time.

- 1 SET DATE & TIME is highlighted. Press the OK button.
- 2 Go to step 4 in [Setting the date & time, anytime](#).

Setting the date & time, anytime

- 1 Turn on the camera. Press the Menu button.
- 2 Press ▲/▼ to highlight Setup Menu , then press the OK button.
- 3 Press ▲/▼ to highlight Date & Time , then press the OK button.
- 4 Press ▲/▼ to adjust the date and time. Press ◀/▶ to advance to the next setting.
- 5 When finished, press the OK button.
- 6 Press the Menu button to exit the menu.

NOTE: Depending on your computer operating system, Kodak EasyShare software may update the camera clock when you connect the camera. See EasyShare software Help for details.

Turning the camera on and off

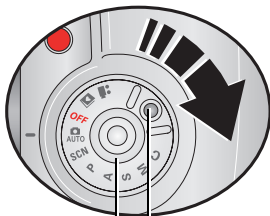

Mode dial lock

Power ring

- While pressing the Mode dial lock, turn the Mode dial from Off to Auto .

The Power ring glows green. The camera screen turns on. The Ready light blinks green while the camera performs a self-check, then turns off when the camera is ready.

- To turn off the camera, turn the Mode dial to Off.

Changing the camera screen in Auto mode

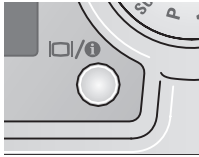
If you want	Then
To turn the camera screen on or off	Press the Display/Info button: <ul style="list-style-type: none"> ■ Once to hide the icons. ■ Again to turn off the camera screen. ■ Again to turn on the camera screen and icons. 
The camera screen off when you turn on the camera in Auto mode	See Liveview (Auto) , page 26.

Checking camera status in capture mode

The icons that appear on the camera screen indicate the camera and picture settings.

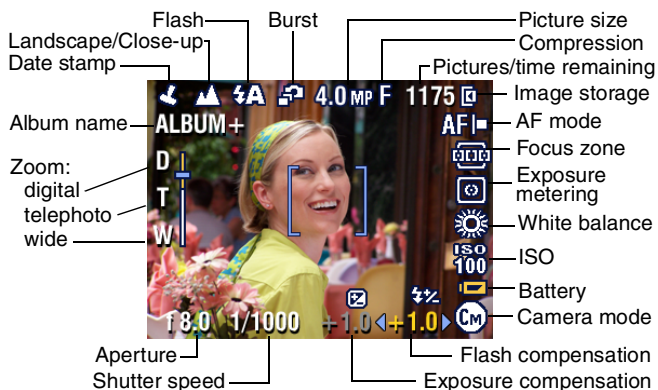

Storing pictures on an optional SD or MMC card

Your camera has 32 MB of internal memory. You can purchase optional SD or MMC cards for removable, reusable storage for your pictures and videos. We recommend Kodak SD or MMC cards. See a dealer of Kodak products or www.kodak.com/go/z730accessories.



CAUTION:

The card can only be inserted one way; forcing it may damage the camera or card. Do not insert or remove a card when the green ready light is blinking; doing so may damage your pictures, card, or camera.

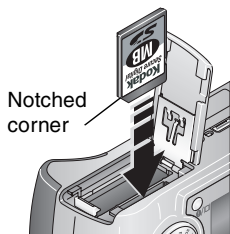

- 1 Turn off the camera, then open the card door.
- 2 Orient the card as shown on the camera body.
- 3 Push the card all the way into the slot.
- 4 Close the door.

To remove the card, turn off the camera. Push the card in, then release it. When the card is partially ejected, pull it out.

See [page 61](#) for storage capacities.

NOTE: When using a card for the first time, we suggest you format it before taking pictures. (See [page 29](#).)

We cannot guarantee compatibility with "high-speed" SD cards such as xSD or Ultra-2; these cards are designed primarily for video or audio.

Using optional lenses

Expand your creativity with a selection of Kodak accessory lenses, offered in wide angle, telephoto, and close-up. See a dealer of Kodak products or www.kodak.com/go/z730accessories.

2

Taking pictures and videos

Taking a picture

- 1 Turn the Mode dial to Auto . (See [page 10](#) for other mode descriptions.)

The camera screen displays the mode name and description. To interrupt the description, press any button. To redisplay the description, press the OK button.



Display/Info button

- 2 Use the camera screen as a viewfinder, or press the Display/Info button to turn off the camera screen and use the viewfinder to frame your subject.

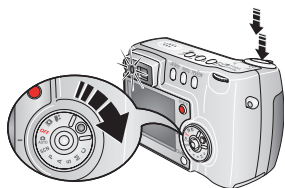

- 3 Press the Shutter button **halfway** to set the exposure and focus.
- 4 When the ready light turns green, continue pressing the Shutter button **completely down** to take the picture.

If the ready light is steady or blinking red, release your finger, recompose the scene, and return to Step 3. When the ready light blinks green, the picture is being saved; you can still take pictures.

NOTE: If you want the camera screen to be off when you turn on the camera, see [Liveview \(Auto\)](#), [page 26](#).

Using the diopter to sharpen the viewfinder

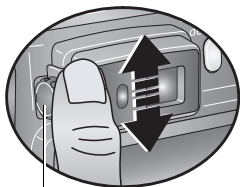

Diopter dial







- 1 Look through the viewfinder.
- 2 Using your left thumb, turn the diopter dial until the viewfinder image is sharp.

Using the auto-focus framing marks

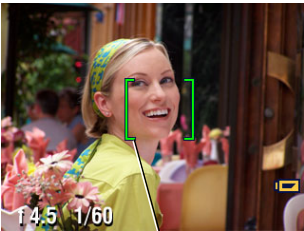
When using the camera screen as a viewfinder, framing marks indicate where the camera is focusing. For the best pictures, the camera attempts to focus on foreground subjects, even if the subjects are not centered in the scene.

- 1 With the camera screen on, press the Shutter button **halfway and hold**.

When the framing marks turn green, focus is accomplished.

 <p>Framing marks</p>	 Center focus
	 Center wide focus
	 Side focus
	 Center and side focus
	 Left and right focus

- 2 Press the Shutter button the rest of the way down to take the picture.

If the camera is not focusing on the desired subject (or if the framing marks disappear and the Ready light blinks red), release your finger, recompose the scene, and return to Step 1.

NOTE: Framing marks do not appear in Landscape or Video mode.

Taking a video

- 1 Turn the Mode dial to Video .
- 2 Use the viewfinder or camera screen to frame your subject.
- 3 Press the Shutter button completely down and release. To stop recording, press and release the Shutter button again.

NOTE: If you prefer, press the Shutter button completely down and hold it for more than 2 seconds to begin recording. To stop recording, release the Shutter button.

You can change optical zoom before (but not during) video recording.

Reviewing the picture or video just taken

After you take a picture or video, the camera screen displays a Quickview for approximately 5 seconds. While the picture or video is displayed, you can:



- **Review:** If you take no action, the picture/video is saved.
- **Play (video):** Press the OK button to play the video. Press $\blacktriangle/\blacktriangledown$ to adjust the volume.
- **Share:** Press the Share button to tag a picture/video for email or as a favorite, or to tag a picture for print. (See [page 40](#).)
- **Delete:** Press the Delete button while the picture/video and  are displayed.

NOTE: Only the final picture of a burst series (see [page 20](#)) is displayed during Quickview. If you select Delete, all pictures in the burst series are deleted. To delete selectively, do so in Review. (See [page 33](#).)

Using optical zoom

Use optical zoom to get up to 4X closer to your subject. Optical zoom is effective when the lens is no closer than 29.5 in. (75 cm) from the subject. You can change optical zoom before (but not during) video recording.

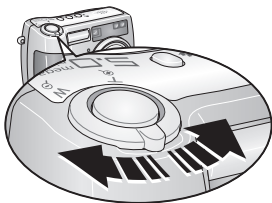

Zoom indicator

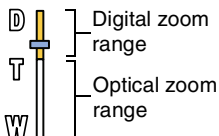

- 1 Use the viewfinder or camera screen to frame your subject.
- 2 Pull or push the Zoom button to zoom in (T) and out (W).

If the camera screen is turned on, the zoom indicator shows when you are in optical zoom range or in digital zoom range.

- 3 Press the Shutter button **halfway and hold** to set the exposure and focus, then press **the rest of the way down** to take the picture. (When taking videos, press and release the Shutter button.)

Using digital zoom

Use digital zoom in any still mode to get an additional 4X magnification beyond optical zoom. Combined zoom settings are from 4.8X to 16X. You must turn on the camera screen before activating digital zoom.

- 1 Press the Display/Info button to turn on the camera screen.
- 2 Pull the Zoom button to the optical zoom limit (4X). Release the button, then pull it again.

The camera screen displays the zoomed image and the zoom indicator.



- 3 Press the Shutter button **halfway and hold** to set the exposure and focus, then press **the rest of the way down** to take the picture.

NOTE: You cannot use digital zoom for video recording.





IMPORTANT: You may notice a decrease in printed image quality when using digital zoom. The blue slider on the zoom indicator pauses, then turns red when the picture quality is approximately 1 MP. For an acceptable 4 x 6 in. (10 x 15 cm) print, ensure that the slider remains blue.



Camera modes















Use this mode	For
 Auto	General picture-taking. Automatically sets exposure, focus, and flash.
SCN Scene	Point-and-shoot simplicity when taking pictures under 16 special conditions. (See Scene modes , page 11.)
P Program	Controlling exposure compensation (how much light enters the camera) and flash compensation. The camera automatically sets the shutter speed and aperture (f-stop) based on the scene lighting. Program mode offers the ease of auto shooting with full access to all menu options. Use the jog dial to select settings. (See Using P, A, S, M, and C modes , page 13 and Using the jog dial to change P, A, S, M, or C mode settings , page 14.) Press the Menu button to change other settings.
A Aperture Priority	Controlling aperture, exposure compensation, flash compensation, and ISO speed. Aperture priority mode is primarily used to control depth of field (the range of sharpness). NOTE: The aperture setting may be affected when using optical zoom. Use the jog dial to select settings. (See Using P, A, S, M, and C modes , page 13 and Using the jog dial to change P, A, S, M, or C mode settings , page 14.) Press the Menu button to change other settings.
S Shutter Priority	Controlling the shutter speed, ISO speed, flash compensation, and exposure compensation. The camera automatically sets the aperture for proper exposure. Shutter priority mode is primarily used to prevent blur when your subject is moving. Use the jog dial to select settings. (See Using P, A, S, M, and C modes , page 13 and Using the jog dial to change P, A, S, M, or C mode settings , page 14.) Press the Menu button to change other settings. Use a tripod for slow shutter speeds.

Use this mode	For
M Manual	Enjoying the highest level of creative control. You set the aperture, shutter speed and ISO speed. Exposure compensation acts as an exposure meter, recommending the proper combination of aperture and shutter speed to produce an acceptable exposure. Use the jog dial to select settings. (See Using P, A, S, M, and C modes, page 13 and Using the jog dial to change P, A, S, M, or C mode settings, page 14.) Press the Menu button to change other settings. To prevent camera shake, use a tripod for slow shutter speeds.
C Custom	The “user-created” mode. For applying P, A, S, & M plus any Custom settings (exposure compensation, flash compensation, ISO speed) which are saved independently of other camera settings. Use the jog dial to select settings. (See Using P, A, S, M, and C modes, page 13 and Using the jog dial to change P, A, S, M, or C mode settings, page 14.) Press the Menu button to choose a capture mode. (See Custom Exposure Mode, page 21.) Press the Menu button to change other settings.
 Favorites	Viewing favorites. (To create and view favorites, see page 40- page 43.)
 Video	Capturing video with sound. (See page 8.)

Scene modes

- 1 Turn the Mode dial to Scene **SCN**.
- 2 Press     to display Scene mode descriptions.
- 3 Press the OK button to choose a Scene mode.

Use this SCN mode	For
 Portrait	Full-frame pictures of people and other subjects.
 Sport	Subjects that are in motion. Shutter speed is fast.

Use this SCN mode	For
 Landscape	Distant scenery. Flash does not fire. Auto-focus framing marks (page 7) are not available in Landscape.
 Close-up	Subjects closer than 28 in. (70 cm).
 Night Portrait	Capturing subject and background at night. Place the camera on a flat, steady surface or use a tripod. Due to slow shutter speeds, advise people to stay still for a few seconds after flash fires.
 Night Landscape	Distant scenery at night. Place the camera on a flat, steady surface or use a tripod.
 Snow	Bright snow scenes.
 Beach	Bright beach scenes.
 Text	Documents, from 3.9 - 23.7 in. (10-60 cm).
 Fireworks	Fireworks. Place the camera on a flat, steady surface or use a tripod.
 Flower	Close-ups of flowers in bright light.
 Manner/ Museum	Quiet occasions. Flash and sound are disabled.
 Self Portrait	Close-ups of yourself, from 3.9 - 23.7 in. (10-60 cm).
 Party	People indoors.
 Children	Action pictures of children in bright light.
 Backlight	Subjects in shadow or “backlit” (when light is behind the subject).

Using P, A, S, M, and C modes



Aperture—also known as f-stop, controls the size of the lens opening. (This determines the depth of field.) The highest and lowest aperture settings may be affected by optical zoom.

Aperture (f)	Depth of field
Larger f number (smaller lens opening)	Makes both the foreground and the background sharp. Good for landscapes and well-lit conditions.
Smaller f number (larger lens opening)	Makes the foreground sharp and the background blurry. Good for portraits and low-light conditions.

Shutter speed—controls how long the shutter stays open. A shaking hand icon warns of slow shutter speeds. (To prevent camera shake, use a tripod.)

Exposure Compensation—controls how much light enters the camera. Add or subtract up to 2 EV in 0.3 EV steps. If the picture is too light, decrease the setting; if it's too dark, increase the setting.

Flash Compensation—controls the flash brightness (brighter: +0.5, +1.0; less bright: -0.5, -1.0). You must be within flash range. Unavailable if flash setting is Off.

ISO—controls sensitivity of the camera sensor (80, 100, 200, 400, 800). Higher settings are more sensitive to light, but may produce unwanted “noise” in a picture. You can only use ISO 800 if you are in the 1.8 MP Picture Size setting. (See [Picture Size](#), page 22.)

Settings apply only in P, A, S, M, and C modes

Settings you change in P, A, S, or M modes apply only to pictures taken in P, A, S, and M modes. Settings you change in C mode apply only to pictures taken in C mode.

For example, if you change the Color Mode to Sepia while in P, A, S, or M mode, then Auto & Scene modes retain the default setting of Color.

NOTE: The settings, including Flash, are maintained for P, A, S, M, and C modes—even when you change modes or turn off the camera. Use Reset to Default (see [page 25](#)) to reset P, A, S, M, or C mode to its default setting.

Using the jog dial to change P, A, S, M, or C mode settings

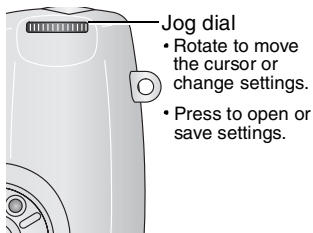

1 Turn the Mode dial to P, A, S, M, or C.

The mode settings are displayed. Available settings are white; unavailable are grey.

2 Use the jog dial:

- Rotate the jog dial ◀/▶ to move the cursor to a setting, such as ± 1.0 .
- Press the jog dial to open the setting.
- Rotate the jog dial ◀/▶ to change the value of the setting. ◀+1.0▶.

(Red settings are out of range and may cause unacceptable image/print quality. Adjust the value higher or lower until it turns yellow.)

- Press the jog dial to save the setting.

- 3 Press the Menu button to change other settings. (See [page 21](#).)
- 4 Take a picture.

Using the flash

Use the flash when you take pictures at night, indoors, or outdoors in heavy shadows. You can change the flash setting in any Still mode; the default flash setting is restored when you exit the mode or turn off the camera.





Zoom position	Flash Range
Wide Angle	2-13.1 ft (0.6-4 m)
Telephoto	2-7.5 ft (0.6-2.3 m)

Turning on the flash

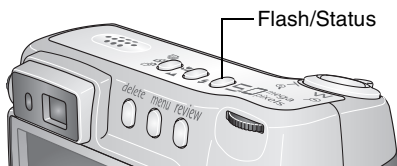
Press the  button to scroll through the flash options.













The active flash icon is displayed in the camera screen status area.











Flash Setting	Flash Fires
 Auto	When the lighting conditions require it.
 Off	Never
 Fill	Every time you take a picture. Use when the subject is in shadow or is "backlit" (when light is behind the subject).
 Red-eye	Once, so the subject's eyes become accustomed to the flash, then fires again when the picture is taken. (If the lighting conditions require flash but do not require Red-eye reduction, the flash may fire only once.)

NOTE: The flash is not available in all modes. See [Flash settings in each mode, page 16](#).

Flash settings in each mode

Capture mode		Default setting	Available settings
	Auto	Auto*	Auto, Off, Fill Flash, Red-eye
P, A, S, M, C	P, A, S, M, or C	Auto	Auto, Off, Fill Flash, Red-eye
SCN Scene Modes			
	Portrait	Auto*	Auto, Off, Fill Flash, Red-eye
	Sport	Auto	Auto, Off, Fill Flash, Red-eye
	Landscape	Off	Off
	Close-up	Off	Auto, Off, Fill Flash
	Night Portrait	Red-eye*	Auto, Off, Fill Flash, Red-eye
	Night Landscape	Off	Off
	Snow	Auto*	Auto, Off, Fill Flash, Red-eye
	Beach	Auto*	Auto, Off, Fill Flash, Red-eye
	Text	Off	Auto, Off
	Fireworks	Off	Off
	Flower	Off	Auto, Off, Fill Flash
	Manner/Museum	Off	Off



Capture mode		Default setting	Available settings
	Self Portrait	Red-eye*	Auto, Off, Fill Flash, Red-eye
	Party	Red-eye*	Auto, Off, Fill Flash, Red-eye
	Children	Auto*	Auto, Off, Fill Flash, Red-eye
	Backlight	Fill	Fill
	Video	Off	Off
	First burst	Off	Off
	Last burst	Off	Off
	Exposure bracketing	Off	Off

* When you change to Auto or Red-eye in these modes, it becomes the default until you change it.

Shooting close-up and landscape pictures

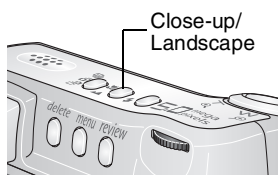
Use the Close-up/Landscape button  to take pictures of scenes that are very close or very far away.



- 1 Set the Mode dial to any Capture mode.
- 2 Press the Close-up/Landscape  button repeatedly until the  or  icon appears in the status bar.
- 3 Take a picture.

Close-up pictures

Use the Close-up setting  to gain sharpness and detail in pictures at close range. Use available light instead of flash if possible. The camera automatically sets the focus distance depending on the zoom position:

Zoom position	Close-up focus distance
Wide angle	3.9 to 23.7 in. (10 to 60 cm)
Telephoto	9.8 to 33.5 in. (25 to 85 cm)

Landscape pictures

Use the Landscape setting  to gain maximum sharpness of far away scenes. With this setting, the camera uses infinity auto-focus. Auto-focus framing marks (see [page 7](#)) are not available in Landscape.

NOTE: Close-up and Landscape are also available as Scene modes (see [page 11](#)).

Using exposure bracketing

Option	Description	Purpose
 Exposure Bracketing	The camera takes 3 pictures—one at +, one at 0, and one at - exposure.	Determine the best exposure level for your conditions based on your evaluation of 3 pictures.

Exposure Bracketing/
Burst



- 1 Set the exposure bracketing interval. (See [Exposure Bracketing Interval](#), page 23.)
- 2 In any Still mode, press the Exposure Bracketing/Burst button until  appears in the status area.
- 3 Press the Shutter button **halfway and hold** to set the auto-focus and exposure.
- 4 Press the Shutter button **the rest of the way down** to take the pictures.

The camera takes 3 pictures. To evaluate them, press the Review button. Exposure bracketing turns off after the pictures are taken.

NOTE: Exposure bracketing is not available in:



- Night Portrait, Night Landscape, and Fireworks scene modes
- Shutter and Manual priority modes when the shutter speed is greater than 0.7 seconds

Using exposure compensation with exposure bracketing

In P, A, and S modes, you can use exposure compensation in conjunction with exposure bracketing.

If exposure compensation is set to	And if the exposure bracketing interval is set to	Then the exposures taken are
0.0	the default +/-0.3	-0.7, 0.0, +0.3
+1.0		+0.7, +1.0, +1.3
-1.0		-1.3, -1.0, -0.7

Using burst

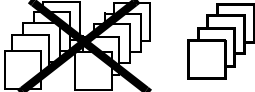
Option	Description	Purpose
 First Burst	Camera takes up to 5 pictures (3 per second) while the Shutter button is pressed.  First 5 pictures are saved.	Capture an expected event. Example: A person swinging a golf club.
 Last Burst	Camera takes up to 30 pictures (3 per second) while the Shutter button is pressed. When the Shutter button is released, only the last 5 pictures are saved.  Last 5 pictures are saved.	Capture an event when the precise timing is uncertain. Example: A child blowing out birthday candles.

- 1 In any Still mode, press the Burst button repeatedly to choose an option.
- 2 Press the Shutter button **halfway and hold** to set the auto-focus and exposure.
- 3 Press the Shutter button **the rest of the way down and hold it** to take the pictures.







The camera stops taking pictures when you release the Shutter button, when the pictures are taken, or when there is no more storage space.





Changing picture-taking settings







You can change settings to get the best results from your camera:





- 1 Press the Menu button. (Some settings are unavailable in some modes.)
- 2 Press / to highlight a setting, then press the OK button.
- 3 Choose an option, then press the OK button.
- 4 Press the Menu button to exit the menu.





Setting	Icon	Options
<p>Custom Exposure Mode</p> <p>Choose a preferred capture mode. (See Custom, page 11.)</p> <p><i>This setting remains until you change it.</i></p>	<p>P ASM</p>	<p>Program (default) </p> <p>Aperture Priority </p> <p>Shutter Priority </p> <p>Manual </p> <p>Available only in Custom (C) mode.</p> <p>NOTE: To use the Jog dial, see page 14.</p>
<p>Self Timer</p> <p>Turn the Self Timer on or off.</p> <p><i>This setting remains until you take the picture, turn the Mode dial, or turn off the camera.</i></p>		<p>On</p> <p>Off (default)</p> <p>NOTE: To cancel the Self Timer before a picture is taken, press the Menu button, then turn the Self Timer off.</p>

Setting	Icon	Options
<p>Picture Size</p> <p>Choose a picture resolution. <i>This setting remains until you change it.</i></p>	★	<p>5 MP—for printing up to 20 x 30 in. (50 x 75 cm).</p> <p>4.4 MP (3:2)—ideal for printing 4 x 6 in. (10 x 15 cm) prints without cropping. Also for printing up to 11 x 14 in. (28 x 36 cm); some cropping may result.</p> <p>4.0 MP—for printing up to 11 x 14 in. (28 x 36 cm); some cropping may result.</p> <p>3.1 MP—for printing up to 11 x 14 in. (28 x 36 cm); some cropping may result.</p> <p>1.8 MP—for printing 4 x 6 in. (10 x 15 cm) prints, emailing, Internet, screen display, or for conserving space.</p>
<p>Compression</p> <p>Choose a compression. <i>This setting remains until you change it. The setting is displayed in the status area as "S" or "F."</i></p>	JPG	<p>Standard (default) </p> <p>Fine </p> <p>NOTE: The Fine setting renders a larger file size.</p>
<p>White Balance</p> <p>Choose your lighting condition. <i>This setting remains until you change it. The setting is displayed on the right side of Liveview if set to Daylight, Tungsten, or Fluorescent.</i></p>		<p>Auto (default)  AWB—automatically corrects white balance. Ideal for general picture taking.</p> <p>Daylight —for pictures in natural lighting.</p> <p>Tungsten —corrects the orange cast of household light bulbs. Ideal for indoor pictures under tungsten or halogen lighting without flash.</p> <p>Fluorescent —corrects the green cast of fluorescent lighting. Ideal for indoor pictures under fluorescent lighting without flash.</p> <p>Unavailable in Auto, Scene, or Video modes.</p>

Setting	Icon	Options
<p>Exposure Bracketing Interval</p> <p>Choose an exposure bracketing interval.</p> <p><i>P, A, S, M, C: This setting remains until you change it or take pictures.</i></p> <p><i>Auto, Scene: This setting remains until you turn the Mode dial or turn off the camera.</i></p>		<p>+/- 0.3 EV (default)</p> <p>+/- 0.7 EV</p> <p>+/- 1.0 EV</p> <p>See Using exposure bracketing, page 19.</p>
<p>Exposure Metering</p> <p>Evaluate light levels at specific areas of a scene.</p> <p><i>This setting remains until you change it. The setting is displayed on the right side of Liveview if set to Center-weight or Center-spot.</i></p>		<p>Multi-pattern (default) —evaluates lighting conditions throughout the image to give an optimum picture exposure. Ideal for general picture taking.</p> <p>Center-weight —evaluates the lighting conditions of the subject centered in the viewfinder. Ideal for backlit subjects.</p> <p>Center-spot —similar to Center-weight, except the metering is concentrated on a smaller area of the subject centered in the viewfinder. (A circle indicates the metering spot.) Ideal when you need an exact exposure of a specific area in the picture.</p> <p>Unavailable in Auto, Scene, or Video modes.</p>





Setting	Icon	Options
<p>Focus Zone</p> <p>Choose a large or concentrated area of focus.</p> <p><i>This setting remains until you change it. The setting is displayed on the right side of Liveview if set to Center-zone or Selectable-zone.</i></p>		<p>Multi-zone (default) —evaluates all zones to give an even picture focus. Ideal for general picture taking.</p> <p>Center-zone —evaluates the small area centered in the viewfinder. Ideal when precise focus of a specific area in the picture is needed.</p> <p>Selectable-zone —move the focus brackets to center, left, or right.</p> <p>NOTE: For the best pictures, the camera is set to Multi-zone when in Landscape mode.</p> <p>Unavailable in Auto, Scene, or Video modes.</p>
<p>AF Control</p> <p>Choose an auto-focus setting.</p> <p><i>This setting remains until you change it. The setting is displayed on the right side of Liveview if set to Single AF or Accessory Lens AF.</i></p>		<p>Continuous AF (default; no icon)—uses external AF sensor and TTL (Through The Lens) AF. Because the camera is always focusing, there is no need to press the Shutter button halfway down to focus.</p> <p>Single AF —uses external AF sensor and TTL-AF when the Shutter button is pressed halfway down.</p> <p>Accessory Lens AF —uses TTL-AF when optional accessory lenses are attached.</p> <p>Unavailable in Video mode.</p>







Setting	Icon	Options
<p>Color Mode Choose color tones. <i>In Auto and Scene modes, this setting remains until you turn the Mode dial or turn off the camera.</i></p>		<p>High Color Natural Color (default) Low Color Black & White Sepia (for pictures with a reddish-brown, antique look.) NOTE: EasyShare software also lets you change a color picture to black-and-white or sepia, but cannot change a black-and-white or sepia picture to color. Unavailable in Video mode.</p>
<p>Sharpness Control picture sharpness. <i>This setting remains until you change it.</i></p>		<p>High Normal (default) Low Unavailable in Auto, Scene, or Video modes.</p>
<p>Reset to Default Reset all picture-taking settings to the defaults.</p>		<p>Reset P, A, S, M, or C mode to its default settings.</p>
<p>Set Album (Still) Choose Album names. <i>This setting remains until you change it. You can apply different Set Album choices to videos and to pictures.</i></p>		<p>On or Off Pre-select album names before you take pictures or videos. Then, all the pictures or videos you take are tagged with those album names. See page 29.</p>
<p>Image Storage Choose a storage location for pictures and videos. <i>This setting remains until you change it.</i></p>		<p>Auto (default)—the camera uses the card if one is in the camera. If not, the camera uses internal memory. Internal Memory—the camera always uses internal memory, even if a card is inserted.</p>







Setting	Icon	Options
<p>Liveview (Auto) Set the camera screen On/Off default for Auto mode. (Press the Display/Info button to manually turn the camera screen on or off.)</p>		<p>On (default)—camera screen is on whenever the camera is on. Off—camera screen is off. Available only in Auto mode.</p>
<p>Video Size Choose pixel dimensions. <i>This setting remains until you change it.</i></p>		<p>640 x 480 (default) 320 x 240</p>
<p>Video Length Choose a default video length (useful in self-timer videos). <i>This setting remains until you turn off the camera.</i></p>		<p>Continuous (default) 5 seconds 15 seconds 30 seconds</p>
<p>Setup Menu Choose additional settings.</p>		<p>See Using setup to customize your camera, page 27.</p>

Using setup to customize your camera

- 1 In any mode, press the Menu button.
- 2 Press ▲/▼ to highlight Setup , then press the OK button.
- 3 Press ▲/▼ to highlight a setting, then press the OK button.
- 4 Choose an option, then press the OK button.
- 5 Press the Menu button to exit.

Setting	Icon	Options
Return to previous menu.		
Quickview Display a picture or video (for 5 seconds) after it is taken.		On (default) Off
Advanced Digital Zoom Choose how digital zoom is employed.		Continuous —no pause between optical and digital zoom. Pause (default) —after reaching 4X optical zoom, the zoom button must be released, then activated again to begin digital zoom. None —digital zoom is disabled.
Print Warning		Pause (default) —when the blue slider on the zoom indicator pauses, the zoom button must be released and reactivated. The slider turns red when the picture may no longer render an acceptable 4 x 6 in. (10 x 15 cm) print. None —no pause.

Setting	Icon	Options
Sound Themes		Shutter Only Default Classical Jazz Sci-Fi NOTE: All sounds are off when the camera is in the Manner/Museum scene mode.
Sound Volume		Off Low (default) Medium High
Mode Description Display mode description when entering a mode.		On (default) Off
Date & Time		See page 2 .
Video Out Choose the regional setting that lets you connect the camera to a television or other external device.		NTSC (default) —used in North America and Japan; most common format. PAL —used in Europe and China.
Orientation Sensor Orient pictures so that they are displayed with the correct side up.		On (default) Off

Setting	Icon	Options
Date Stamp Imprint the date on pictures.		Choose a date option, or turn off the feature. (Default is off.)
Video Date Display Display Date/Time at the start of video playback.		Choose a date/time option, or turn off the feature. (Default is YYYY/MM/DD.)
Language		Choose a language.
Format  CAUTION: Formatting deletes all pictures and videos, including those that are protected. Removing a card during formatting may damage the card.		Memory Card —deletes everything on the card; formats the card. Cancel —exits without making a change. Internal Memory —deletes everything in internal memory including email addresses, album names, and favorites; formats the internal memory.
About View camera information.		





Pre-tagging for album names

Use the Set Album (Still or Video) feature to pre-select album names before you take pictures or videos. Then, all the pictures or videos you take are tagged with those album names.

First—on your computer

Use Kodak EasyShare software that was included with your camera to create album names on your computer. Then copy up to 32 album names to the camera's album name list the next time you connect the camera to the computer. See Kodak EasyShare software Help for details.

Second—on your camera

- 1 In any mode, press the Menu button.
- 2 Press / to highlight Set Album , then press the OK button.
- 3 Press / to highlight an album name, then press the OK button. Repeat to select more than one album name.

Selected albums are noted with a check mark.

- 4 To remove a selection, highlight an album name and press the OK button. To remove all album selections, select Clear All.
- 5 Highlight Exit, then press the OK button.

Your selections are saved. If you turn on the camera screen, your album selection is displayed on the screen. A plus (+) after the album name means more than one album is selected.

- 6 Press the Menu button to exit the menu.

Third—transfer to your computer

When you transfer the tagged pictures or videos to your computer, Kodak EasyShare software opens and categorizes your pictures in the appropriate album. See the Kodak EasyShare software Help for details.

3

Reviewing pictures and videos

Press the Review button to view and work with your pictures and videos. To save battery power, use the optional Kodak EasyShare camera or printer dock, or Kodak 5-volt AC adapter. (See www.kodak.com/go/z730accessories.)

Viewing single pictures and videos

- 1 Press the Review button.
- 2 Move the joystick to scroll backward or forward through pictures and videos. (For fast scrolling, hold the joystick .)
- 3 Press the Review button to exit Review.

NOTE: Pictures taken at the 4.4 MP (3:2) quality setting are displayed at a 3:2 aspect ratio with a black bar at the top of the screen.

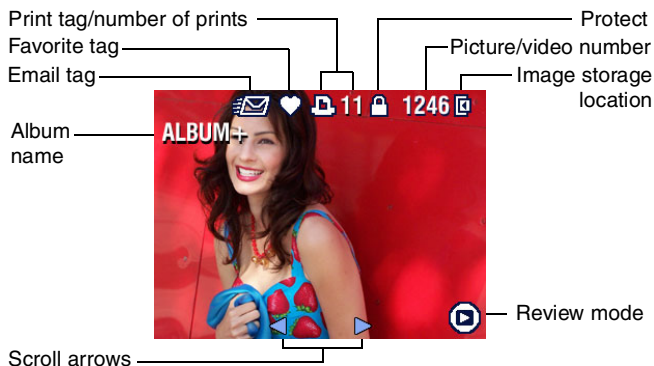

Changing the camera screen

Pictures/videos are displayed with associated icons. Press the Display/Info button:

- Once to turn off the icons.
- Again to display picture/video information.
- Again to display picture/video with icons.

Viewing multiple pictures and videos

- 1 Press the Review button.
- 2 Move the joystick ▼.

Thumbnails of pictures and videos are displayed.

To display the previous or next row of thumbnails, move the joystick ▲/▼.

To scroll through the thumbnails one at a time, move the joystick ◀/▶.

To display a single view of the selected picture, press the OK button.

Playing a video

- 1 Press the Review button.
- 2 Move the joystick ◀/▶ to locate a video. (In Multi-up view, highlight a video, then press the OK button. When a video is highlighted in Multi-up view, the video duration is displayed at the top of the camera screen.)
- 3 To play or pause a video, press the OK button.

NOTE: You can also press the Menu button, highlight , then press the OK button.





To adjust the volume, move the joystick ▲/▼.

To return to the beginning of the video, move the joystick ◀ during playback.

To replay the video, press the OK button.

To go to the previous or next picture or video, move the joystick ◀/▶.





Deleting pictures and videos

- 1 Press the Review button.
- 2 Move the joystick   to locate a picture or video (or highlight one in multiple view), then press the Delete button.
- 3 Move the joystick   to highlight an option, then press the OK button:
 - PICTURE or VIDEO**—deletes the displayed picture or video.
 - EXIT**—exits the Delete screen.
 - ALL**—deletes all pictures and videos from your current storage location.

To delete more pictures and videos, return to Step 2.







NOTE: You cannot delete protected pictures and videos this way. Remove protection before deleting (see [page 34](#)).

Magnifying pictures



- 1 Press the Review button, then locate a picture.
- 2 Pull or push the Zoom button to magnify the picture between 1X and 8X.
 - To see different parts of the picture, move the joystick    .
 - To redisplay the picture at the 1X (original) size, press the OK button.
 - To exit Magnify, press the OK button.
 - To exit Review, press the Review button.

Changing optional review settings

In Review, press the Menu button to access optional review settings.

	Album (page 35)		Copy (page 37)
	Protect (page 34)		Multi-up (page 32)
	Image Storage (page 25)		Setup Menu (page 26)
	Slide Show (page 36)		

Protecting pictures and videos from deletion

- 1 Press the Review button, then locate the picture or video.
- 2 Press the Menu button.
- 3 Move the joystick  to highlight Protect , then press the OK button.
The picture or video is protected and cannot be deleted. The Protect icon  appears with the protected picture or video.
- 4 To remove protection, press the OK button again.
- 5 Press the Menu button to exit the menu.



CAUTION:

Formatting internal memory or an SD or MMC card deletes all (including protected) pictures, videos. (Formatting internal memory also deletes email addresses, album names, and favorites. To restore them, see EasyShare software Help.)



Tagging pictures/videos for albums

Use the Album feature in Review to tag the pictures and videos in your camera with album names.

First—on your computer

Use Kodak EasyShare software (V 3.0 or higher) to create album names on your computer. Then copy up to 32 album names to the camera's internal memory. See Kodak EasyShare software Help for details.

Second—on your camera

- 1 Press the Review button, then locate the picture or video.
- 2 Press the Menu button.
- 3 Move the joystick  to highlight Album , then press the OK button.
- 4 Move the joystick  to highlight an album folder, then press the OK button.

To add other pictures to the same album, move the joystick  to scroll through pictures. When you see the picture you want, press the OK button.

To add the pictures to more than one album, repeat step 4 for each album.

The album name appears with the picture. A plus (+) after the album name means the picture was added to more than one album.

To remove a selection, highlight an album name and press the OK button. To remove all album selections, select Clear All.

Third—transfer to your computer

When you transfer the tagged pictures and videos to your computer, the Kodak EasyShare software opens and categorizes your pictures and videos in the appropriate album folder. See Kodak EasyShare software Help for details.

Running a slide show

Use the Slide Show to display your pictures and videos on the camera screen. To run a slide show on a television or on any external device, see [page 37](#). To save battery power, use an optional Kodak 5V AC adapter. (Visit www.kodak.com/go/z730accessories.)

Starting the slide show

- 1 Press the Review button, then press the Menu button.
- 2 Move the joystick ▲/▼ to highlight Slide Show , then press the OK button.
- 3 Move the joystick ▲/▼ to highlight Begin Show, then press the OK button.

Each picture and video is displayed once, in the order in which you took them.

To interrupt the Slide Show, press the OK button.

Changing the slide show display interval

You can set the display interval between 3 and 60 seconds. (The default is 5 seconds.)

- 1 On the Slide Show menu, move the joystick ▲/▼ to highlight Interval, then press the OK button.
- 2 Select a display interval.
To scroll through the seconds quickly, hold the joystick ▲/▼.
- 3 Press the OK button.

The interval setting remains until you change it.

Running a continuous slide show loop

When you turn on Loop, the slide show is continuously repeated.

- 1 On the Slide Show menu, move the joystick ▲/▼ to highlight Loop, then press the OK button.
- 2 Move the joystick ▲/▼ to highlight On, then press the OK button.

The slide show repeats until you press the OK button or until battery power is exhausted. This setting remains until you change it.

Displaying pictures and videos on a television

You can display pictures and videos on a television, computer monitor, or any device equipped with a video input. (Image quality on a television screen may not be as good as on a computer monitor or when printed.)

NOTE: Ensure that the Video Out setting (NTSC or PAL) is correct (see [Video Out, page 28](#)). The slide show stops if you connect or disconnect the cable while the slide show is running.

- 1 Connect the audio/video cable (included) from the camera video-out port to the television video-in port (yellow) and audio-in port (white). See your television user's guide for details.
- 2 Review pictures and videos on the television.



Copying pictures and videos

You can copy pictures and videos from a card to internal memory or from internal memory to a card.

Before you copy, make sure that:

- A card is inserted in the camera.
- The camera's picture storage location is set to the location **from** which you are copying. See [Image Storage, page 25](#).

Copy pictures or videos:

- 1 Press the Review button, then press the Menu button.
- 2 Move the joystick  to highlight Copy , then press the OK button.
- 3 Move the joystick  to highlight an option:

PICTURE or VIDEO—copies the current picture or video.

EXIT—returns to the Review menu.

ALL—copies all pictures and videos from your selected storage location to the other location.

- 4 Press the OK button.

NOTE: Pictures and videos are copied, not moved. To remove pictures and videos from the original location after they are copied, delete them (see [page 33](#)). Tags that you applied for print, email, and favorites are not copied. Protection settings are not copied. To apply protection to a picture or video, see [page 34](#).

Viewing picture/video information

- 1 Press the Review button.
- 2 Press the Display/Info button once to hide icons, again to display picture/video information, and once more to show icons.
- 3 To view information on the next or previous picture or video, move the joystick . Press the Menu button to exit the menu.

4

Installing the software

Install the software



CAUTION:

Install EasyShare software *before* connecting the camera or optional dock to the computer. Failure to do so may cause the software to install incorrectly.

- 1 Close all software applications that are open on your computer (including anti-virus software).
 - 2 Place the Kodak EasyShare software CD into the CD-ROM drive.
 - 3 Install the software:
 - Windows OS**—if the install window does not appear, choose Run from the Start menu and type **d:\setup.exe** where **d** is the drive letter that contains the CD.
 - Mac OS X**—double-click the CD icon on the desktop, then click the Install icon.
 - 4 Follow the on-screen instructions to install the software.
 - Windows OS**—select Complete to automatically install all applications. Select Custom to choose the applications you wish to install.
 - Mac OS X**—follow the on-screen instructions.
- NOTE: When prompted, take a few minutes to electronically register your camera and software. This lets you receive information regarding software updates and registers some of the products included with the camera. You must be connected to your Internet service provider to register electronically. To register later, see www.kodak.com/go/register.
- 5 Restart the computer. If you turned off anti-virus software, turn it back on. See the anti-virus software manual for details.



5

Sharing pictures and videos



Press the Share button to “tag” your pictures and videos.

When they are transferred to your computer, you can share them by:

	Pictures	Videos
 Print (page 41)	✓	
 Email (page 42)	✓	✓
 Favorite (page 43) for easy organization on your computer and for sharing on your camera	✓	✓



NOTE: Share tags remain until removed. If a tagged picture/video is copied on the camera, the Share tag is **not** copied. (If a tagged picture/video is copied in EasyShare software, the Share tag is copied.) In a burst series, only the last picture is tagged during Quickview.

When can I tag my pictures and videos?

Press the Share button to tag pictures/videos:

- Any time. (The most recent picture/video taken is then displayed.)
- Just after you take a picture/video, during Quickview (see [page 8](#)).
- After pressing the Review button (see [page 31](#)).

Tagging pictures for printing

- 1 Press the Share button. Press ◀/▶ to locate a picture.
- 2 Press ▲/▼ to highlight Print , then press the OK button.*
- 3 Press ▲/▼ to select the number of copies (0-99). Zero removes the tag for that picture.
The Print icon  appears in the status area. The default quantity is one.
- 4 **Optional:** You can apply a print quantity to other pictures. Press ◀/▶ to locate a picture. Keep the print quantity as is, or press ▲/▼ to change it. Repeat this step until the desired print quantity is applied to the pictures.
- 5 Press the OK button. Then press the Share button to exit the menu.

* To tag all pictures in the storage location, highlight Print All, press the OK button, then indicate the number of copies as described above. Print All is not available in Quickview.

To remove the print tagging for all pictures in the storage location, highlight Cancel Prints, then press the OK button. Cancel Prints is not available in Quickview.

Printing tagged pictures

When you transfer the tagged pictures to your computer, the Kodak EasyShare software print screen opens. For details on printing, click the Help button in the Kodak EasyShare software.

For more information on printing from your computer, printer dock, or card, see [page 46](#).

NOTE: For the best 4 x 6 in. (10 x 15 cm) prints, set the camera to the 4.4 MP (3:2) print quality setting.
See [Picture Size, page 22](#).

Tagging pictures and videos for emailing

First—on your computer

Use Kodak EasyShare software (V 3.0 or higher) to create an email address book on your computer. Then copy up to 32 email addresses to the camera's internal memory. See the Kodak EasyShare software Help for details.

Second—tag pictures/videos on your camera

- 1 Press the Share button. Press ◀/▶ to locate a picture/video.
- 2 Press ▲/▼ to highlight Email , then press the OK button.

The email icon  appears in the status area.

- 3 Press ▲/▼ to highlight an email address, then press the OK button.

To tag other pictures/videos with the same address, press ◀/▶ to scroll through them. When the picture you want is displayed, press OK.

To send the pictures/videos to more than one address, repeat step 3 for each address.

Selected addresses are checked.

- 4 To remove a selection, highlight a checked address and press the OK button. To remove all email selections, highlight Clear All.
- 5 Press ▲/▼ to highlight Exit, then press the OK button.

The email icon  appears in the status area.

- 6 Press the Share button to exit the menu.









Third—transfer and email

When you transfer the tagged pictures/videos to your computer, the email screen opens and lets you send them to the addresses you specified. See the Kodak EasyShare software Help for details.

Tagging pictures as favorites

You can preserve your favorite pictures in the Favorites  section of your camera's internal memory, then share them with friends and family.





NOTE: When you transfer pictures from your camera to your computer, all pictures (including favorites) are stored on your computer at full size. Favorite pictures - smaller copies of your originals - are loaded back to your camera, so you can share and enjoy more.

1. Take pictures	
2. Tag pictures as favorites	<ol style="list-style-type: none">1 Press the Share button. Press / to locate a picture.2 Press / to highlight Favorite , then press the OK button. <i>The Favorite icon  appears in the status area. To remove the tag, press the OK button again.</i> <p>Press the Share button to exit the menu.</p>
3. Transfer pictures	<ol style="list-style-type: none">1 To enjoy full functionality, load and use the EasyShare software that was packaged with this camera. (See page 39.)2 Connect the camera to the computer using the USB cable (see page 46) or an EasyShare dock. <i>The first time you transfer pictures, a software wizard helps you make choices about your favorite pictures. Then, your pictures are transferred to the computer. Favorite pictures (smaller versions of the originals) are loaded to the Favorites section of your camera's internal memory.</i>
4. View favorites on your camera	<ol style="list-style-type: none">1 Turn the Mode dial to Favorites .2 Press / to scroll through favorites. <p>To exit Favorites mode, turn the Mode dial to any other position.</p>

NOTE: The camera holds a limited number of favorites. Use Camera Favorites in the EasyShare software to customize the size of your camera Favorites section. For more information, click the Help button in the Kodak EasyShare software.



Optional settings

In Favorites mode, press the Menu button to access optional settings.

	Slide Show (page 36)		Remove all favorites (Removing all favorites from your camera, page 44)
	Multi-up (page 32)		Setup Menu (page 26)

NOTE: Pictures taken at the 4.4 MP (3:2) quality setting are displayed at a 3:2 aspect ratio with a black bar at the top of the screen. (See [Picture Size, page 22.](#))

Removing all favorites from your camera

- 1 Turn the Mode dial to Favorites .
- 2 Press the Menu button.
- 3 Highlight , then press the OK button.

All pictures stored in the Favorites section of internal memory are removed. Favorites are restored to your camera the next time you transfer pictures to the computer. To remove single favorites, do so in EasyShare software.





- 4 Press the Menu button to exit the menu.

Preventing favorites from transferring to the camera

- 1 Open the Kodak EasyShare software. Click the My Collection tab.
- 2 Go to the Albums view.
- 3 Click the Camera Favorites Album for your camera.
- 4 Click Remove Album.

The next time you transfer pictures from your camera to the computer, use the Camera Favorites Wizard/Assistant in EasyShare software to recreate your Camera Favorites Album or to turn off the Camera Favorites feature.

Printing and emailing favorites

- 1 Turn the Mode dial to Favorites . Press /  to locate a picture.
- 2 Press the Share button.
- 3 Highlight Print  or Email , then press the OK button.

NOTE: Favorites that were taken on this camera (not imported from another source) are good for prints up to 4 x 6 in. (10 x 15 cm).

6

Transferring and printing pictures



CAUTION:

Install Kodak EasyShare software *before* connecting the camera or optional dock to the computer. Failure to do so may cause the software to install incorrectly.

Transferring pictures/videos with the USB cable

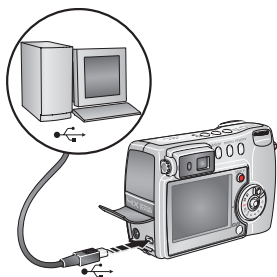

- 1 Turn off the camera.
- 2 Plug the labeled  end of the USB cable into the labeled USB port on your computer. See your computer user's guide for details.
- 3 Plug the other end of the USB cable into the labeled USB port on the camera.
- 4 Turn on the camera.

EasyShare software opens on your computer. The software prompts you through the transfer process.

NOTE: Visit www.kodak.com/go/howto for an online tutorial on connecting.

Also available for transferring

You can also use these Kodak products to transfer your pictures and videos:

- Kodak EasyShare camera dock series 3, Kodak EasyShare printer dock series 3
- Kodak multi-card reader, Kodak SD multimedia card reader-writer

Purchase these and other accessories at a dealer of Kodak products or www.kodak.com/go/z730accessories.

www.kodak.com/go/support

Printing pictures

Printing with a Kodak EasyShare printer dock series 3

Dock your camera with an EasyShare printer dock series 3 and print with or without a computer! (See [Dock compatibility for your camera](#), page 49.)

Direct printing with a PictBridge enabled printer

Your camera features PictBridge technology, so you can print directly to PictBridge enabled printers. You need:

- Camera with fully-charged batteries, or with optional Kodak 5-volt AC adapter
- PictBridge enabled printer
- USB cable included with your camera

Connecting the camera to a PictBridge enabled printer

- 1 Turn off the camera and printer.
- 2 Optional: If you have a Kodak 5-volt AC adapter (optional accessory), plug it into the camera and into an electrical outlet.

IMPORTANT: *Do not use the AC adapter included with the Kodak EasyShare camera dock or printer dock to power your camera.*

- 3 Connect the appropriate USB cable from the camera to the printer. (See your printer user guide for details. See www.kodak.com/go/z730accessories to order cables.)

Printing from a PictBridge enabled printer

- 1 Turn on the printer. Turn on the camera.

The PictBridge logo is displayed, followed by the current picture and menu. (If no pictures are found, a message is displayed.) If the menu interface turns off, press any button to redisplay it.

- 2 Press **▲/▼** to choose a printing option, then press the OK button.

Current Picture—Press **◀/▶** to choose a picture. Choose the number of copies.

Tagged Pictures—If your printer is capable, print pictures that you tagged for printing and choose a print size.

Index Print—Print thumbnails of all pictures. This requires one or more sheets of paper. If the printer is capable, choose a print size.

All Pictures—Print all pictures in internal memory, on a card, or in Favorites. Choose the number of copies.

Image Storage—Access internal memory, a card, or Favorites.

NOTE: During direct printing, pictures are not permanently transferred or saved to the computer or printer.

Disconnecting the camera from a PictBridge enabled printer

- 1 Turn off the camera and printer.
- 2 Disconnect the USB cable from the camera and the printer.

Ordering prints online

Kodak EasyShare gallery (www.kodakgallery.com) is one of the many online print services offered in Kodak EasyShare software. You can easily:

- Upload your pictures.
- Edit, enhance, and add borders to your pictures.
- Store pictures, and share them with family and friends.
- Order high-quality prints, photo greeting cards, frames, and albums—and have them delivered to your door.

Printing from an optional SD or MMC card

- Print pictures when you insert your card into a printer with an SD/MMC slot. See your printer user's guide for details.
- Make prints at an SD/MMC-capable Kodak picture maker. (Contact a location prior to visiting. See www.kodak.com/go/picturemaker.)
- Take the card to your local photo retailer for professional printing.

Dock compatibility for your camera

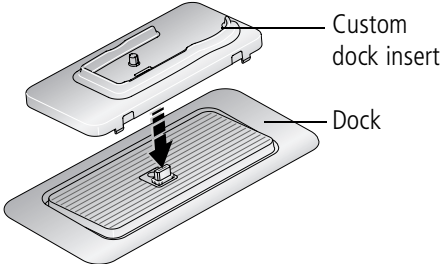
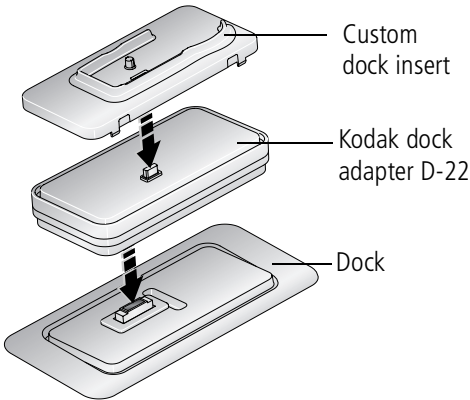
Kodak EasyShare dock	Docking configuration
<ul style="list-style-type: none"> ■ printer dock series 3 ■ camera dock series 3 	 <p>Custom dock insert</p> <p>Dock</p>
<ul style="list-style-type: none"> ■ printer dock ■ printer dock plus ■ printer dock 6000 ■ camera dock 6000 	 <p>Custom dock insert</p> <p>Kodak dock adapter D-22</p> <p>Dock</p>
<ul style="list-style-type: none"> ■ printer dock 4000 ■ camera dock II ■ LS420, LS443 camera dock 	<p>Not compatible</p>

Purchase camera docks, printer docks, and other accessories at a dealer of Kodak products or www.kodak.com/go/z730accessories.

7

Troubleshooting

When you have questions about your camera, start here. Additional technical information is available in the ReadMe file located on the Kodak EasyShare software CD. For updates to Troubleshooting information, see www.kodak.com/go/z730support.

Camera problems

Status	Cause
The camera does not turn on	<ul style="list-style-type: none"> ■ Remove, then reinsert the battery. ■ Insert a charged battery.
The camera does not turn off and the lens does not retract	<ul style="list-style-type: none"> ■ Place the camera on a Kodak EasyShare camera or printer dock (sold separately), then try again. ■ Connect the camera to a Kodak 5-volt AC adapter (sold separately), then try again.
Camera buttons and controls do not function	See page 1 for more battery information.
The camera screen does not turn on	<ul style="list-style-type: none"> ■ In any capture mode, press the Display/Info button. ■ Turn the camera off, then on again. <p>To change the camera screen setting so that it is on whenever the camera is on, see Liveview (Auto), page 26.</p>
In Review, a blue or black screen is displayed instead of a picture	<ul style="list-style-type: none"> ■ Transfer the picture to the computer. ■ Transfer <i>all</i> pictures to the computer. <p>See page 46.</p>
The pictures remaining number does not decrease after taking a picture	<ul style="list-style-type: none"> ■ Continue taking pictures. The camera is operating normally. (The camera estimates the number of pictures remaining after each picture is taken, based on picture size and content.)

Status	Cause
Picture orientation is not accurate	<ul style="list-style-type: none"> ■ Set the Orientation Sensor (page 28).
Flash does not fire	<ul style="list-style-type: none"> ■ Check flash setting, and change as needed (page 15).
Battery life is short	<ul style="list-style-type: none"> ■ Wipe the contacts with a clean, dry cloth before inserting a battery in the camera. ■ Insert a charged battery (page 2).
You cannot take a picture	<ul style="list-style-type: none"> ■ Turn the camera off, then on again. ■ Depress the shutter button all the way (page 6). ■ Insert a charged battery (page 2). ■ Wait until the ready light is green before attempting to take another picture. ■ Transfer pictures to the computer (page 46), delete pictures from the camera (page 33), switch image storage locations (page 25), or insert a card with available memory (page 5). ■ If the camera is in Favorites mode, turn the Mode dial to a different mode.

Computer/connectivity problems

Status	Cause
The computer does not communicate with the camera	<ul style="list-style-type: none"> ■ Turn on the camera. ■ Insert a charged battery (page 2). ■ Make sure the USB cable is securely connected on the camera and the computer port (page 46). ■ Make sure the EasyShare software is installed (page 39). <p>NOTE: This camera is not supported by Mac OS 8.6 or 9.x. You may capture pictures on a card, then use a card reader to transfer them to the computer.</p>

Status	Cause
Slide Show does not run on an external video device	<ul style="list-style-type: none"> ■ Adjust the camera Video Out setting (NTSC or PAL, page 28). ■ Make sure the external device settings are correct (see the device's user's guide).

Picture quality problems

Status	Cause
The picture is too dark or underexposed	<ul style="list-style-type: none"> ■ Use Fill flash (page 15) or change your position so light is not behind the subject. ■ Move so that the distance between you and the subject is within the effective flash range (page 15). ■ To automatically set exposure and focus, press the Shutter button halfway and hold. When the ready light glows green, press the Shutter button the rest of the way down to take the picture. ■ Decrease the shutter speed or increase the ISO speed (page 13).
The picture is too light	<ul style="list-style-type: none"> ■ Turn the flash off (page 15). ■ Move so that the distance between you and the subject is within the effective flash range (see page 15). ■ To automatically set exposure and focus, press the Shutter button halfway and hold. When the ready light glows green, press the Shutter button the rest of the way down to take the picture. ■ Increase the shutter speed or decrease the ISO speed (page 13).
The picture is not clear	<ul style="list-style-type: none"> ■ To automatically set exposure and focus, press the Shutter button halfway and hold. When the ready light glows green, press the Shutter button the rest of the way down to take the picture. ■ Clean the lens (page 59). ■ Make sure the camera is not in Close-up mode if you are more than 23.7 in. (60 cm) from your subject. ■ Place the camera on a flat, steady surface or use a tripod.

Camera ready light status

Status	Cause
Ready light glows steady green.	Shutter button is pressed halfway down. Focus and exposure are set.
Ready light blinks green.	Picture is being processed and saved to the camera.
	Pictures are being transferred to computer; camera is connected.
	Camera firmware upgrade is in process.
Ready light glows steady orange.	Camera is in Favorites mode.
Ready light blinks orange.	Flash is not charged. Wait. Resume picture taking when the light stops blinking and turns off.
	Auto-exposure or auto-focus are not locked. Release the Shutter button and recompose the picture.
Ready light blinks red and camera turns off.	Battery is low or exhausted. Recharge the battery (page 1).
Ready light glows steady red.	Camera's internal memory or card is full. Transfer pictures to the computer (page 46), delete pictures from the camera (page 33), switch image storage locations (page 25), or insert a card with available memory (page 5).
	Camera processing memory is full. Wait. Resume picture taking when the light turns green.
	Card is read-only. Change image storage location to internal memory (page 25), or use a different card.
	Memory card speed is slow. Card cannot be used to take videos. Change storage location to internal memory (page 25). Use this card to take pictures only.

8

Getting help

Helpful links

Camera

Get support for your product (FAQs, troubleshooting information, arrange for repairs, etc.)	www.kodak.com/go/z730support
Purchase camera accessories (camera docks, printer docks, lenses, cards, etc.)	www.kodak.com/go/z730accessories
Download the latest camera firmware and software	www.kodak.com/go/z730downloads
See online demonstrations of your camera	www.kodak.com/go/howto

Software

Get information on EasyShare software	www.kodak.com/go/easysharesw (or click the Help button in EasyShare software)
Get help with the Windows operating system and working with digital pictures	www.kodak.com/go/pcbasics

Other

Get support for other cameras, software, accessories, more	www.kodak.com/go/support
Get information on Kodak EasyShare printer docks	www.kodak.com/go/printerdocks
Get information on Kodak inkjet products	www.kodak.com/go/inkjet
Optimize your printer for truer, more vibrant colors	www.kodak.com/go/onetouch
Register your camera	www.kodak.com/go/register
Learn to take better pictures	www.kodak.com/go/betterpictures

Telephone customer support

If you have questions concerning this product, you may speak with a customer support representative:

Australia	1800 147 701
Austria	0179 567 357
Belgium	02 713 14 45
Brazil	0800 150000
Canada	1 800 465 6325
China	800 820 6027
Denmark	3 848 71 30
Ireland	01 407 3054
Finland	0800 1 17056
France	01 55 1740 77
Germany	069 5007 0035
Greece	00800 44140775
Hong Kong	800 901 514
India	91 22 617 5823
Italy	02 696 33452
Japan	03 5540 9002
Korea	00798 631 0024

Netherlands	020 346 9372
New Zealand	0800 440 786
Norway	23 16 21 33
Philippines	1 800 1 888 9600
Poland	00800 4411625
Portugal	021 415 4125
Singapore	800 6363 036
Spain	91 749 76 53
Sweden	08 587 704 21
Switzerland	01 838 53 51
Taiwan	0800 096 868
Thailand	001 800 631 0017
Turkey	00800 448827073
United Kingdom	0870 243 0270
United States	1 800 235 6325
Outside the US	585 726 7260
International Toll Line	+44 131 458 6714
International Toll Fax	+44 131 458 6962

For the most up-to-date listings, visit:

www.kodak.com/US/en/digital/contacts/DAInternationalContacts.shtml

Camera specifications

For more specifications, visit www.kodak.com/go/z730support

CCD—1/2.5 in. CCD, 4:3 aspect ratio

Output image size (image quality mode)—

- 2576 x 1932 (5 M) pixels
- 2576 x 1716 (3:2) (4.4 M) pixels
- 2304 x 1728 (4.0 M) pixels
- 2048 x 1536 (3.1 M) pixels
- 1552 x 1164 (1.8 M) pixels

Display—Color display 2.2 in. (5.6 cm) color hybrid LCD, 640 x 240 (153 K) pixels

Viewfinder—Real-image optical with diopter

Preview—Frame rate: 27.6 fps (13 fps @ low light level); Field-of-view: 100%.
Automatic black & white in very dark conditions.

Lens—4X optical zoom lens, f/2.8-4.8, 33-132 mm (35 mm equivalent)

Focus system—Hybrid auto-focus system with continuous control. Multi-, Center-, or Selectable-zones. Working range:

- 19.7 in. (50 cm)-infinity @ wide
- 29.5 in. (75 cm)-infinity @ telephoto
- 3.9 - 23.7 in. (10-60 cm) @ wide macro
- 9.8 - 33.5 in. (25-85 cm) @ telephoto macro

Digital zoom—1-4X with 0.2X step; not supported for movie capture

Accessory lens thread—Yes

Lens barrier—Built-in

Exposure metering—TTL-AE Multi-pattern AE, Center-weighted AE, Center-spot AE.

Exposure range—

AE range: EV 6.0 to 16.3

Full range: EV -3.0 to 16.3

Exposure mode—

Programmed AE mode: Auto, Program, and 16 Scene modes

Aperture Priority AE: f/2.8, 3.4, 4, 4.8, 5.6 @ wide; f/4.8, 5.6, 6.7, 8.0, 9.5 @ tele

Shutter Priority AE: 64-1/1000 sec. @ wide

Exposure Compensation: +/-2.0 EV with 1/3 EV step

Shutter speed—64-1/2000 sec.

ISO speed—

Auto: 80-160

Selectable: 80, 100, 200, 400, 800 (800 available only @ 1.8 MP)

Electronic flash—Guide no. 9.5 @ ISO 160; auto flash with photo sensor. Working range @ ISO 160:

2-13.1 ft (0.6-4.0 m) @ Wide

2-7.5 ft (0.6-2.3 m) @ Tele

Flash modes—Auto, Fill, Red-eye, Off

Capture modes—Auto, Program, Aperture Priority, Shutter Priority, Manual, Custom, Close-up, Landscape, Scene, Video

Jog dial—Used to adjust Exposure Compensation, Aperture Priority AE, Shutter Priority AE, ISO, Flash Compensation, Full Manual Exposure.

Burst mode—

First burst: Maximum 5 pictures @ 2.5 fps.

Last burst: Maximum 30 frames @ 2.5 fps (last 5 frames saved).

Video capture—

Image size: QVGA (320 x 240), VGA (640 x 480)

Frame rate: QVGA 20 fps; VGA 12 fps

Image file format—

Still: EXIF 2.21 (JPEG compression); file organization DCF

Video: QuickTime (CODEC H.263, G.711)

Image storage—32 MB internal flash memory. Optional MMC or SD Card .
(The SD logo is a trademark of the SD Card Association.)

Quickview—Yes

Video output—NTSC or PAL

Power—Kodak EasyShare rechargeable Li-Ion battery (KLIC-5000); optional 5V AC adapter; EasyShare printer dock series 3; EasyShare camera dock series 3

Communication with computer—USB 2.0 (PIMA 15740 protocol) via USB cable, EasyShare camera dock or printer dock

Languages—English, German, Spanish, French, Italian, Portuguese, Chinese, Korean, Japanese

Self timer—10 seconds

Sound feedback—Power up, shutter, self timer, error

White balance—Auto, Daylight, Tungsten, Fluorescent

Auto sleep mode—Yes. 8 minutes

Color modes—High Color, Natural Color, Low Color, Black & White, Sepia

Sharpness—High, Normal, Low

PictBridge support—Yes

Date stamp—None, YYYYMMDD, MMDDYYYY, DDMMYYYY

Tripod mount—1/4 inch

Camera size—3.9 in. (100 mm) x 2.7 in. (69 mm) x 1.6 in. (40 mm) @ power off

Camera weight—7.9 oz (224 g) without battery or card

Tips, safety, maintenance

- If water is inside the camera, turn off the camera and remove the batteries and card. Allow components to air-dry for at least 24 hours before using the camera again.
- Rapid temperature changes can cause harmful condensation. Keep your camera in an airtight plastic bag and let it adjust to temperature before removing it from the bag.
- Blow gently on the lens or camera screen to remove dust and dirt. Wipe gently with a soft, lint-free cloth or an untreated lens-cleaning tissue. Do not use cleaning solutions unless designed specifically for camera lenses. Do not allow chemicals, such as suntan lotion, to contact painted surfaces.
- Service agreements are available in some countries. Contact a dealer of Kodak products for more information.
- Please dispose of batteries according to local and national regulations.
- For digital camera disposal or recycling information, contact your local authorities. In the US, visit the Electronics Industry Alliance Web site at www.eiae.org or visit www.kodak.com/go/z730support.

Important battery information

Kodak battery replacement types/battery life

Actual battery life may vary based on usage.

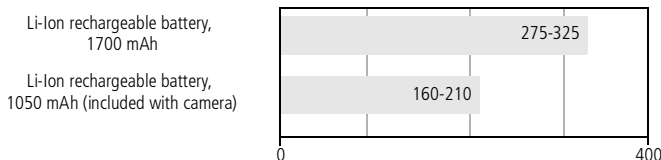

Battery life per CIPA testing method (Approx. number of pictures). Actual life may vary based on usage.

We recommend using only a Kodak EasyShare rechargeable Li-Ion battery. Not all manufacturers' 3.7V rechargeable Li-Ion batteries are compatible with the camera. Damage caused by unauthorized accessories is not covered under warranty.

Extending battery life

- Limit the following activities that deplete battery power:
 - Reviewing your pictures on the camera screen
 - Excessive use of the flash
 - Using the camera screen as a viewfinder
- Dirt on the battery contacts can affect battery life. Wipe the contacts with a clean, dry cloth before inserting a battery in the camera.
- Battery performance is reduced at temperatures below 41° F (5° C). When using your camera in cold weather, carry spare batteries and keep them warm. Do not discard cold batteries that do not work; when they return to room temperature, they may be usable.

Visit www.kodak.com/go/z730accessories for:

Kodak EasyShare camera dock series 3—powers your camera, transfers pictures to your computer, and charges your battery.

Kodak EasyShare printer dock series 3—powers your camera, makes 4 x 6 in. (10 x 15 cm) prints, transfers pictures, and charges your battery.

Kodak 5-volt AC adapter—powers your camera.

Battery safety and handling

- Do not allow batteries to touch metal objects, including coins. Otherwise, a battery may short circuit, discharge energy, become hot, or leak.
- Please dispose of batteries according to local and national regulations.

For more information on batteries, see

www.kodak.com/global/en/service/batteries/batteryUsage.jhtml

Storage capacities

File sizes can vary. You may be able to store more or fewer pictures and videos. Favorites take up additional space in internal memory and reduce storage capacity.

Picture storage capacity (standard compression)

	Number of pictures				
	5.0 MP	4.4 MP	4.0 MP	3.1 MP	1.8 MP
32 MB internal memory	17	19	21	27	43
32 MB SD/MMC	19	22	24	30	48
64 MB SD/MMC	38	44	48	60	96
128 MB SD/MMC	76	88	96	120	192
256 MB SD/MMC	152	176	192	240	384
512 MB SD/MMC	304	352	384	480	768

Picture storage capacity (fine compression)

	Number of pictures				
	5.0 MP	4.4 MP	4.0 MP	3.1 MP	1.8 MP
32 MB internal memory	8	9	10	12	21
32 MB SD/MMC	9	10	11	14	24
64 MB SD/MMC	18	20	22	28	48
128 MB SD/MMC	36	40	44	56	96
256 MB SD/MMC	72	80	88	112	192
512 MB SD/MMC	144	160	176	224	384

Video storage capacity

	Minutes/seconds of video	
	VGA (640 x 480)	QVGA (320 x 240)
16 MB SD/MMC	1 min. 30 sec.	1 min. 43 sec.
32 MB internal memory	2 min. 42 sec.	3 min. 7 sec.
32 MB SD/MMC	3 min.	3 min. 27 sec.
64 MB SD/MMC	6 min. 1 sec.	6 min. 55 sec.
128 MB SD/MMC	12 min. 2 sec.	13 min. 50 sec.
256 MB SD/MMC	24 min. 4 sec.	27 min. 41 sec.
512 MB SD/MMC	48 min. 9 sec.	55 min. 22 sec.

Power-saving features

If no action for	The camera	To turn it back on
1 minute	Screen turns off.	Press the Display/Info button.
8 minutes	Enters auto power off.	Press a button or insert/remove card.
3 hours	Turns off.	Turn Mode dial Off, then back on.

Upgrading your software and firmware

Download the latest versions of the software included on the EasyShare software CD and the camera firmware (the software that runs on the camera). See www.kodak.com/go/z730downloads.

Warranty

Limited warranty

Kodak warrants Kodak EasyShare digital cameras and accessories (excluding batteries) to be free from malfunctions and defects in both materials and workmanship for one year from the date of purchase.

Retain the original dated sales receipt. Proof of the date of purchase will be required with any request for warranty repair.

Limited warranty coverage

This limited warranty will be honored only within the geographical location that Kodak digital cameras and accessories were purchased.

Kodak will REPAIR or REPLACE Kodak EasyShare digital cameras and accessories if they fail to function properly during the warranty period, subject to any conditions and/or limitations stated herein. Such repair service will include all labor as well as any necessary adjustments and/or replacement parts. Such repair or replacement is the sole remedy under this warranty.

If replacement parts are used in making repairs, these parts may be remanufactured, or may contain remanufactured materials. If it is necessary to replace the entire product, it may be replaced with a remanufactured product.

Limitations

Request for Warranty service will not be accepted without proof of date of purchase, such as a copy of the original dated Kodak EasyShare digital camera or accessory sales receipt. (Always keep the original for your records.)

This warranty does not apply to the battery(s) used in digital cameras or accessories. This warranty does not cover circumstances beyond Kodak's control, nor problems caused by failure to follow the operating instructions in the Kodak EasyShare digital cameras and accessories User's Guides.

THIS WARRANTY DOES NOT APPLY WHEN FAILURE IS DUE TO SHIPPING DAMAGE,

ACCIDENT, ALTERATION, MODIFICATION, UNAUTHORIZED SERVICE, MISUSE, ABUSE, USE WITH INCOMPATIBLE ACCESSORIES OR ATTACHMENTS, FAILURE TO FOLLOW KODAK'S OPERATION, MAINTENANCE OR REPACKING INSTRUCTIONS, FAILURE TO USE ITEMS SUPPLIED BY KODAK (SUCH AS ADAPTERS AND CABLES), OR CLAIMS MADE AFTER THE DURATION OF THIS WARRANTY.

Kodak makes no other express or implied warranty for this product. In the event that the exclusion of any implied warranty is ineffective under the law, the duration of the implied warranty will be one year from the purchase date.

The option of replacement is Kodak's only obligation. Kodak will not be responsible for any special, consequential or incidental damages resulting from the sale, purchase, or use of this product, regardless of the cause. Liability for any special, consequential or incidental damages (including but not limited to loss of revenue or profit, downtime costs, loss of the use of the equipment, cost of substitute equipment, facilities or services, or claims of your customers for such damages resulting from the purchase, use or failure of the product), regardless of cause or for breach of any written or implied warranty is expressly disclaimed and excluded herefrom.

Your rights

Some states or jurisdictions do not allow exclusion or limitation of incidental or consequential damages, so the above limitation or exclusion may not apply to you. Some states or jurisdictions do not allow limitations on how long an implied warranty lasts, so the above limitation may not apply to you.

This warranty gives you specific rights, and you may have other rights which vary from state to state or by jurisdiction.

Outside the United States and Canada

In countries other than the United States and Canada, the terms and conditions of this warranty may be different. Unless specific Kodak warranty is communicated to the purchaser in writing by a Kodak company, no warranty or liability exists beyond any minimum requirements imposed by law, even though defect, damage, or loss may be by negligence or other act.

Regulatory compliance

FCC compliance and advisory



Kodak EasyShare Z730 zoom digital camera

This equipment has been tested and found to comply with the limits for a Class B digital device, pursuant to Part 15 of the FCC Rules. These limits are designed to provide reasonable protection against harmful interference in a residential installation.

This equipment generates, uses, and can radiate radio frequency energy and, if not installed or used in accordance with the instructions, may cause harmful interference to radio communications. However, there is no guarantee that interference will not occur in a particular installation.

If this equipment does cause harmful interference to radio or television reception, which can be determined by turning the equipment off and on, the user is encouraged to try to correct the interference by one or more of the following measures: 1) reorient or relocate the receiving antenna; 2) increase the separation between the equipment and the receiver; 3) connect the equipment to an outlet on a circuit different from that to which the receiver is connected; 4) consult the dealer or an experienced radio/TV technician for additional suggestions.

Any changes or modifications not expressly approved by the party responsible for compliance could void the user's authority to operate the equipment. Where shielded interface cables have been provided with the product or specified additional components or accessories elsewhere defined to be used with the installation of the product, they must be used in order to ensure compliance with FCC regulation.

Canadian DOC statement

DOC Class B Compliance—This Class B digital apparatus complies with Canadian ICES-003.

Observation des normes-Class B—Cet appareil numérique de la classe B est conforme à la norme NMB-003 du Canada.

Waste Electrical and Electronic Equipment labeling



In the European Union, do not discard the product as municipal waste. Contact your local authorities or go to www.kodak.com for recycling program information.

VCCI Class B ITE

この装置は、情報処理装置等電波障害自主規制協議会（VCCI）の基準に基づきクラスB情報技術装置です。この装置は、家庭環境で使用することを目的としていますが、この装置がラジオやテレビジョン受信機に近接して使用されると、受信障害を引き起こすことがあります。
取扱説明書に従って正しい取り扱いをして下さい。

English translation:

This is a Class B product based on the standard of the Voluntary Control Council for Interference from Information Technology Equipment (VCCI). If this is used near a radio or television receiver in a domestic environment, it may cause radio interference. Install and use the equipment according to the instruction manual.

MPEG-4

Use of this product in any manner that complies with the MPEG-4 visual standard is prohibited, except for use by a consumer engaging in personal and non-commercial activities.

Index

A

- A/V out, 37
- about picture, video, 38
- about this camera, 29
- accessories
 - battery, 60
 - buying, 54
 - lenses, 5
 - printer dock, 47
 - SD/MMC card, 5
- advanced digital zoom, 27
- AF control, 24
- album, 25
- albums, tagging pictures for, 29, 35
- aperture, 13
- auto, 10
 - flash, 15
 - focus framing marks, 7
 - power-down, 62

B

- backlight, 12
- battery
 - charge via charger, 1
 - expected life, 59
 - extending life, 60
 - inserting, 2
 - safety and handling, 60
- beach, 12
- bracketing interval, 23
- burst, 20
- button

- close-up/landscape, 18
- delete, 8
- flash/status, 15
- OK, 4, 32
- on/off, ii
- review, 31
- share, ii, 40
- zoom, 9

C

- cable
 - audio/video, 37
 - USB, 46
- camera dock connector on camera, ii
- camera screen
 - reviewing pictures, 31
 - reviewing videos, 31
- Canadian compliance, 66
- caring for your camera, 59
- charging
 - battery via charger, 1
 - lights, battery charger, 1
- children, 12
- clock, setting, 2
- close-up, 12
 - scenes, 18
- close-up pictures, 18
- color mode, 25
- compression, 22
- computer
 - connecting camera, 46
 - transfer to, 46

connector for camera dock, ii
copy pictures
 card to memory, 37
 memory to card, 37
 to computer via USB cable, 46
custom, 11
custom exposure mode, 21
customer support, 55

D

date setting, 2
date stamp, 29
deleting
 during quickview, 8
 from internal memory, 33
 from MMC/SD Card, 33
dial
 diopter, 7
 jog, 14
 mode, 10
digital zoom, 27
diopter, 7
displaying slide show, 36
disposal, recycling, 59
distant scenes, 18
dock
 printer, 47
downloading pictures, 46

E

EasyShare software, 39
emailing pictures, videos, 42
exposure compensation, 13
exposure metering, 23

external video device
 viewing pictures, videos, 37

F

favorites, 11
 removing, 44
 settings, 44
 tagging, 43
FCC compliance, 65
file format, 58
fireworks, 12
firmware, upgrading, 62
first burst, 20
flash
 compensation, 13
 range, 15
 settings, 15
 unit, i
flower, 12
focus framing marks, 7
focus zone, 24
format, 29

H

help
 troubleshooting, 50
 web links, 54

I

icons, mode dial, 10
image file format, 58
image storage, 25
information
 about pictures, videos, 38
inserting

battery, 2
SD/MMC card, 5
installing software, 39
internal memory
storage capacity, 61, 62
ISO, 13

J

jog dial, 14
joystick, ii

K

knob, diopter, 7
Kodak EasyShare software
installing, 39
upgrading, 62
Kodak web sites, 54

L

landscape, 12, 18
language, 29
last burst, 20
lens, i
lens, accessory, 5
light
ready, ii
sensor, i
liveview, 26
locating holes for dock, ii

M

Mac OS, installing software, 39
magnify picture, 33
manner/museum, 12
manual, 11

memory
inserting card, 5
mode description, 28
mode dial, ii, 10
modes
aperture priority, 10
auto, 10
backlight, 12
beach, 12
children, 12
close-up, 12
custom, 11
custom exposure, 21
favorites, 11
fireworks, 12
flower, 12
landscape, 12
manner/museum, 12
manual, 11
night landscape, 12
night portrait, 12
party, 12
portrait, 11
program, 10
SCN, 10
self portrait, 12
shutter priority, 10
snow, 12
sport, 11
text, 12

N

night landscape, 12
night portrait, 12

O

OK button, 4, 32
online prints, ordering, 48
optical zoom, 9
orientation sensor, 28

P

party, 12
PASM mode
 screen options, 13
PictBridge printer, 47
picture size, 22
pictures
 copying, 37
 deleting, 33
 emailing tagged, 42
 magnifying, 33
 printing, 47
 printing tagged, 41
 reviewing, 31
 storage capacity, 61, 62
 tagging, 35
 taking, modes, 10
 transfer via USB cable, 46
portrait, 11
power
 auto off, save, 62
 camera, 3
 switch, ii
print warning, 27
printer dock, 47
printing
 from a card, 48
 optimizing printer, 54

order online, 48
PictBridge, 47
pictures, 47
tagged pictures, 48
 with EasyShare printer dock, 47
program, 10
protecting pictures, videos, 34

Q

quickview, 27
 using, 8

R

ReadMe file, 50
ready light, ii
recycling, disposal, 59
red-eye, flash, 15
regulatory information, 65
removing favorites, 44
repair, 54
reset to default, PASM, C, 25
review button, 31
reviewing pictures
 as you take them, 8
 camera screen, 31
 deleting, 33
 magnifying, 33
 slide show, 36
reviewing videos
 camera screen, 31
 deleting, 33
 slide show, 36
running slide show, 36

S

- safety, 59
- SCN, 10
- SD/MMC card
 - inserting, 5
 - printing from, 48
 - storage capacities, 61, 62
- self portrait, 12
- self timer, 21
 - light, i
- sensor, light, i
- service and support telephone numbers, 55
- setting
 - AF control, 24
 - album, 25
 - bracketing interval, 23
 - color mode, 25
 - compression, 22
 - custom exposure mode, 21
 - date and time, 2
 - date stamp, 29
 - digital zoom, 27
 - exposure metering, 23
 - flash, 15
 - focus zone, 24
 - image storage, 25
 - language, 29
 - liveview, 26
 - mode description, 28
 - orientation sensor, 28
 - picture size, 22
 - picture taking mode, 10
 - print warning, 27
 - quickview, 27
 - reset to default, 25
 - self timer, 21
 - sharpness, 25
 - sound themes, 28
 - sound volume, 28
 - video date display, 29
 - video length, 26
 - video out, 28
 - video size, 26
 - white balance, 22
- share button, ii, 40
- sharpness, 25
- shutoff, auto, 62
- shutter speed, 13
- shutter, problems, 51
- sleep mode, 62
- slide show
 - problems, 52
 - running, 36
- snow, 12
- software
 - installing, 39
 - upgrading, 62
- sound themes, 28
- sound volume, 28
- specifications, 56
- sport, 11
- storage capacity, 61, 62
- support
 - online, 54
 - technical, 55

T

- tagging, 29
 - favorites, 43
 - for email, 42
 - for print, 41
 - when to tag, 40
- tagging pictures
 - for albums, 29, 35
- taking a picture, 6
- telephone support, 55
- television, slide show, 37
- text, 12
- time, setting, 2
- tips
 - battery guidelines, 60
 - maintenance, 59
 - ReadMe file, 50
 - safety, 59
- transfer, via USB cable, 46
- trash can, deleting, 8
- tripod socket, ii
- troubleshooting
 - camera, 50
 - computer connectivity, 51
 - picture quality, 52
 - ready light, 53
- turning camera on and off, 3

U

- upgrading software, firmware, 62
- URLs, Kodak web sites, 54
- USB (universal serial bus)
 - connection location, i
 - transferring pictures, 46

V

- VCCI compliance, 66
- video
 - length, 26
 - out, 28
 - size, 26
- video date display, 29
- videos
 - copying, 37
 - deleting, 33
 - emailing tagged, 42
 - reviewing, 31
 - storage capacities, 62
 - transfer to computer, 46
 - viewing, 31
- viewfinder, ii
- viewing picture
 - after taking, 8, 31
 - magnified, 33
- viewing picture, video information, 38

W

- warranty, 63
- white balance, 22
- Windows OS, installing software, 39
- wrist strap post, i

Z

- zoom
 - optical, digital, 9